



2018 FDR MAPS

-  A PHASE
-  B PHASE
-  C PHASE





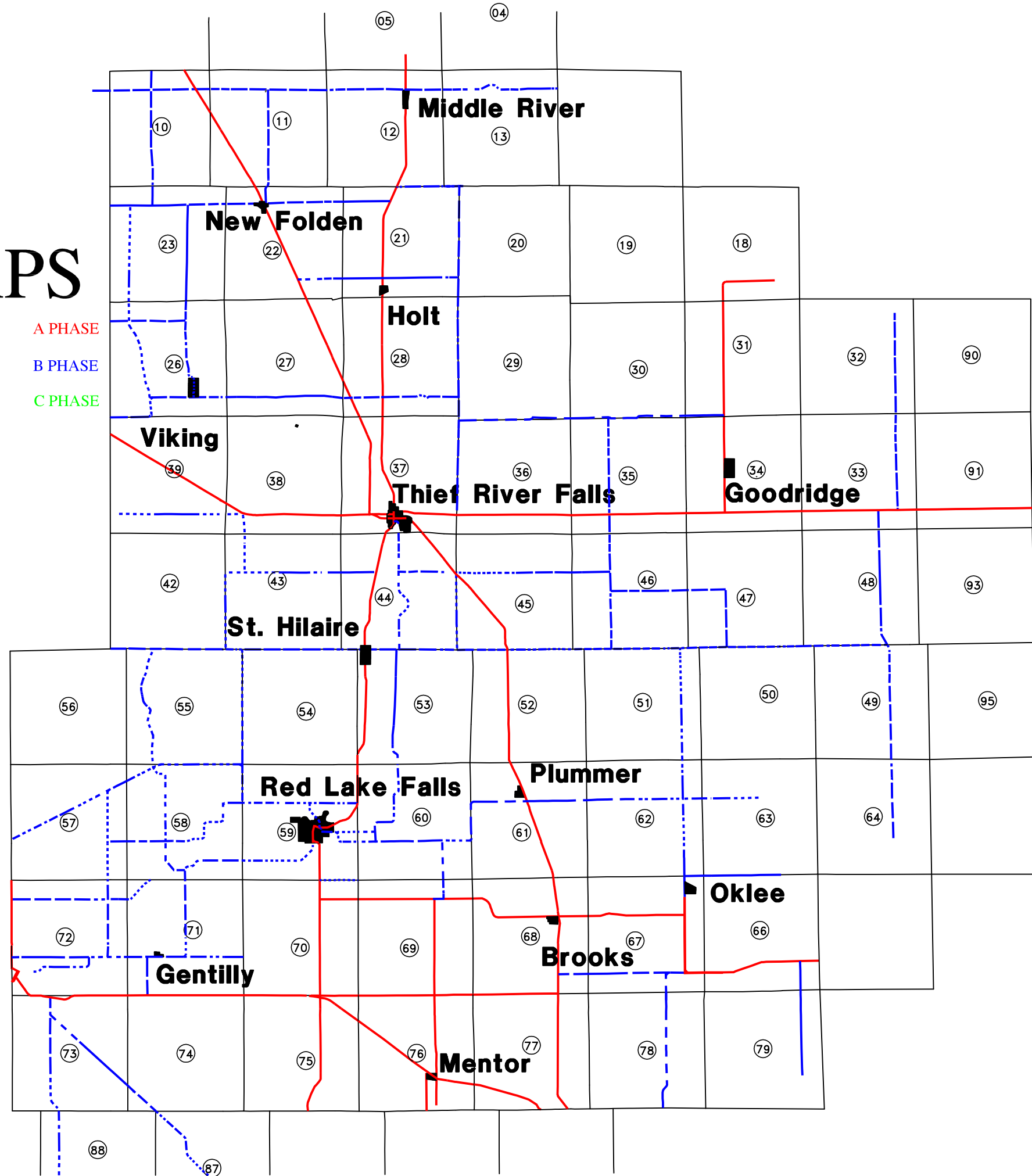













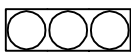

**RED LAKE ELECTRIC
COOPERATIVE, INC.**









MEI
Engineering, Inc.

RLEC MAP SYMBOLS

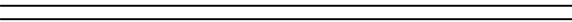
	REGULATOR		PH A OH (1)
	OCR		PH B OH (2)
	SECTIONALIZER		PH C OH (3)
	AIR BREAK SWITCH		2 PHASE OH
	SUBSTATION		3 PHASE OH
	RECTIFIER		PH A UG (1)
	OIL SWITCH		PH B UG (2)
	FAULT INDICATOR		PH C UG (3)
	END OF LINE VOLT METER		2 PHASE UG
			3 PHASE UG

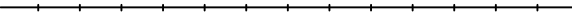
PHASING #s			SUBSTATIONS #s	
1 = PH 1	4 = PH 1+2	7 = PH 1+2+3	1 = HOLT	5 = HUOT
2 = PH 2	5 = PH 1+3		2 = HAZEL	6 = HIGHLANDING
3 = PH 3	6 = PH 2+3		3 = TERREBONNE	7 = OKLEE
			4 = DAKOTA	8 = MORRIS OWEN
				10 = GENTILLY CREEK

	COUNTY ROAD #		UNIMPROVED ROAD
	STATE ROAD #		GRAVEL ROAD
	US ROAD #		PAVED ROAD
			RAILROAD
			SECTION LINE
			TOWNSHIP LINE

Note: All unmarked overhead lines are considered #4 ACSR 15kV.
 All unmarked underground lines are considered 1/0 15kV XLP.

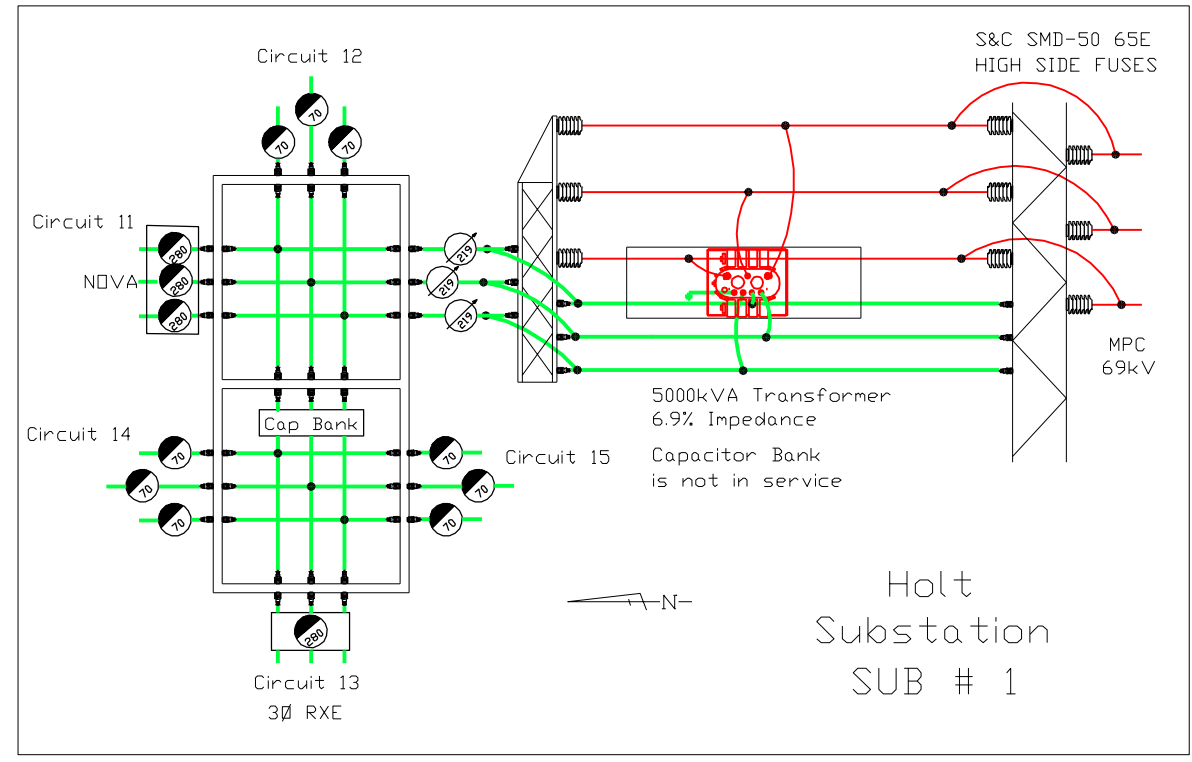
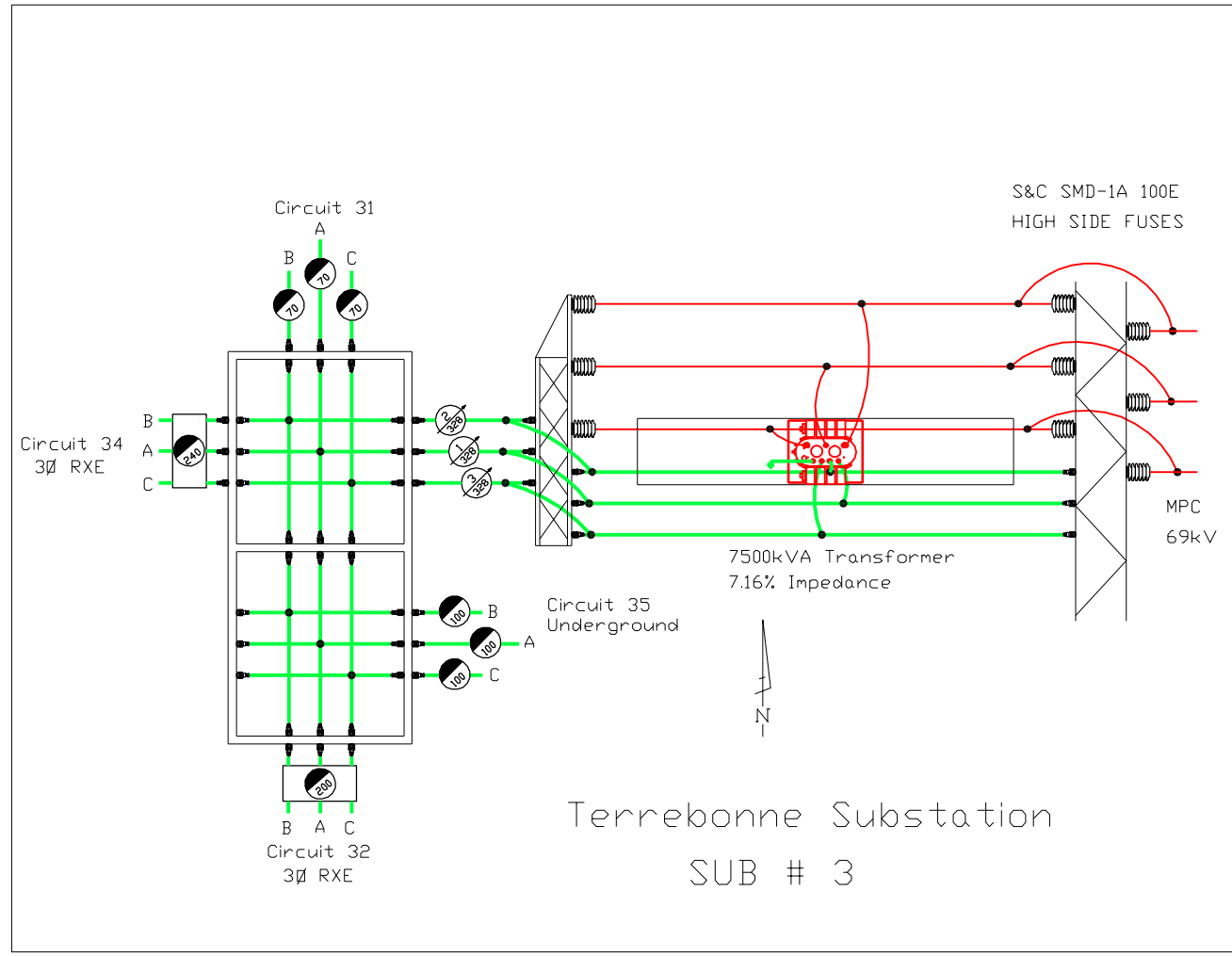
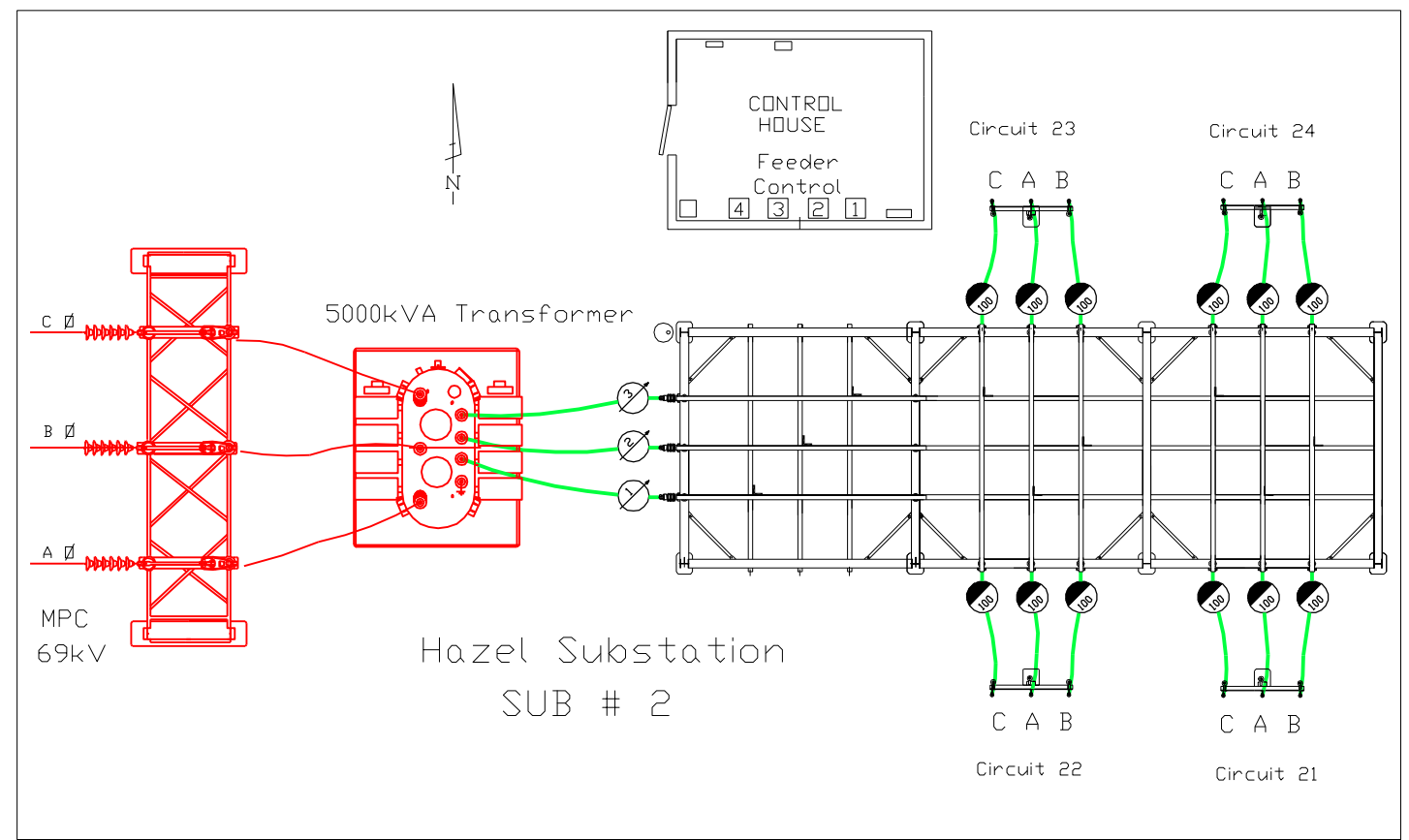
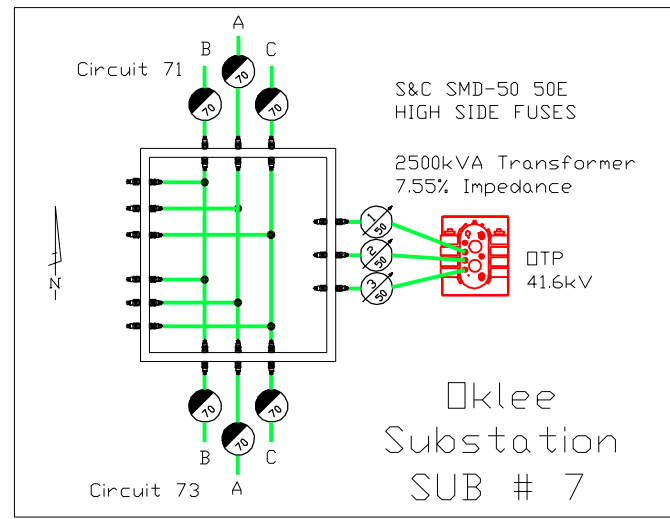

RED LAKE ELECTRIC COOP

RED LAKE FALLS, MN

DWN: STEVE CONELY 4/9/02 REV: Chris 10/10/2017

SUBSTATION DRAWINGS

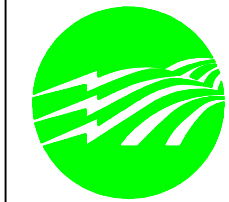
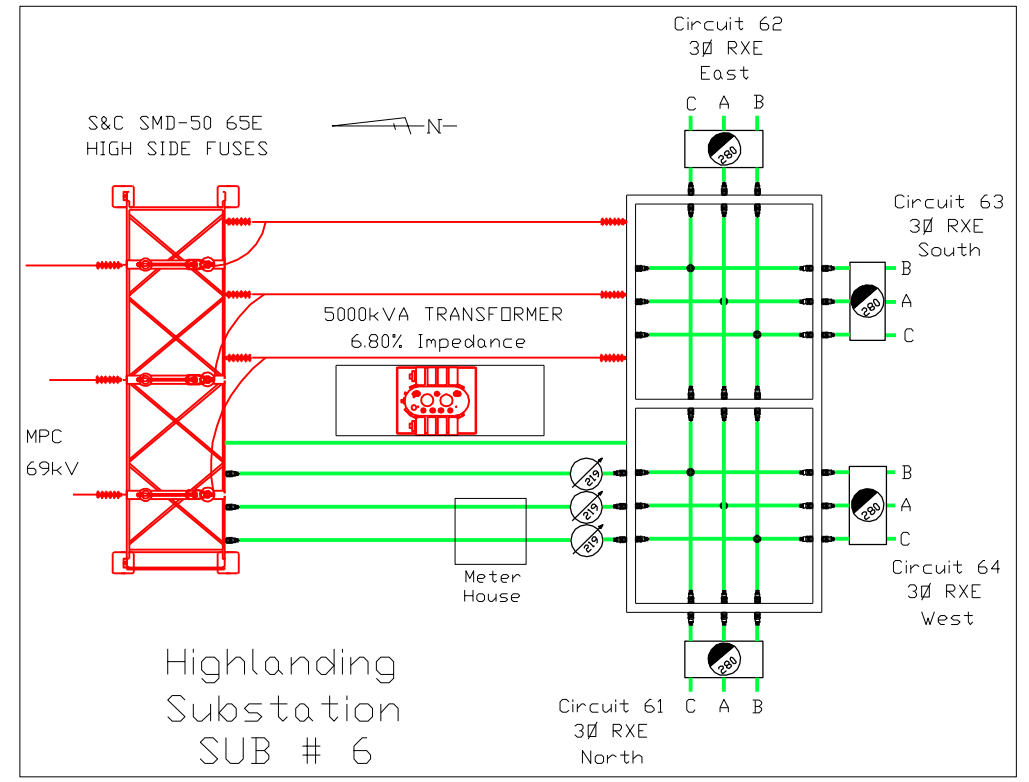
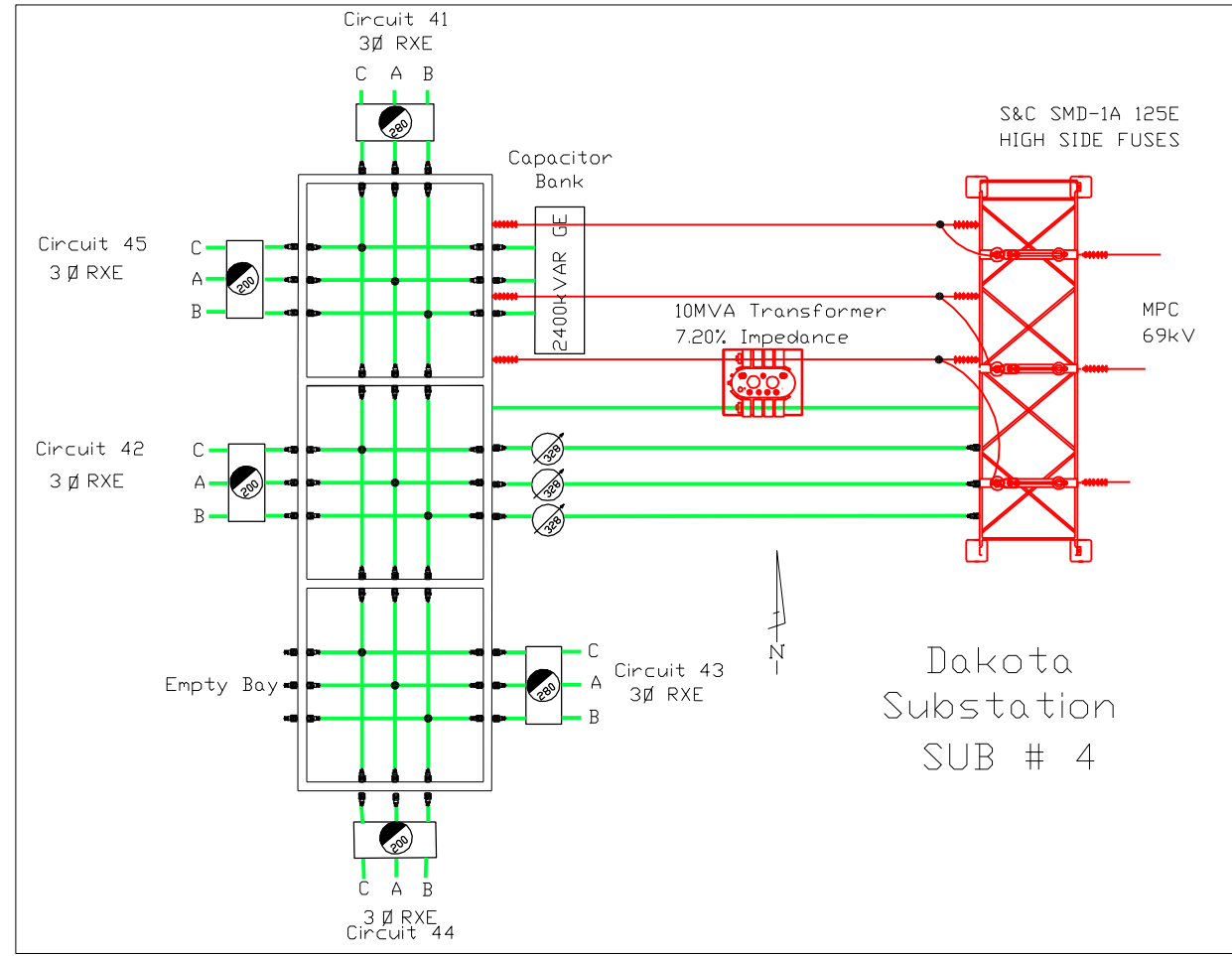
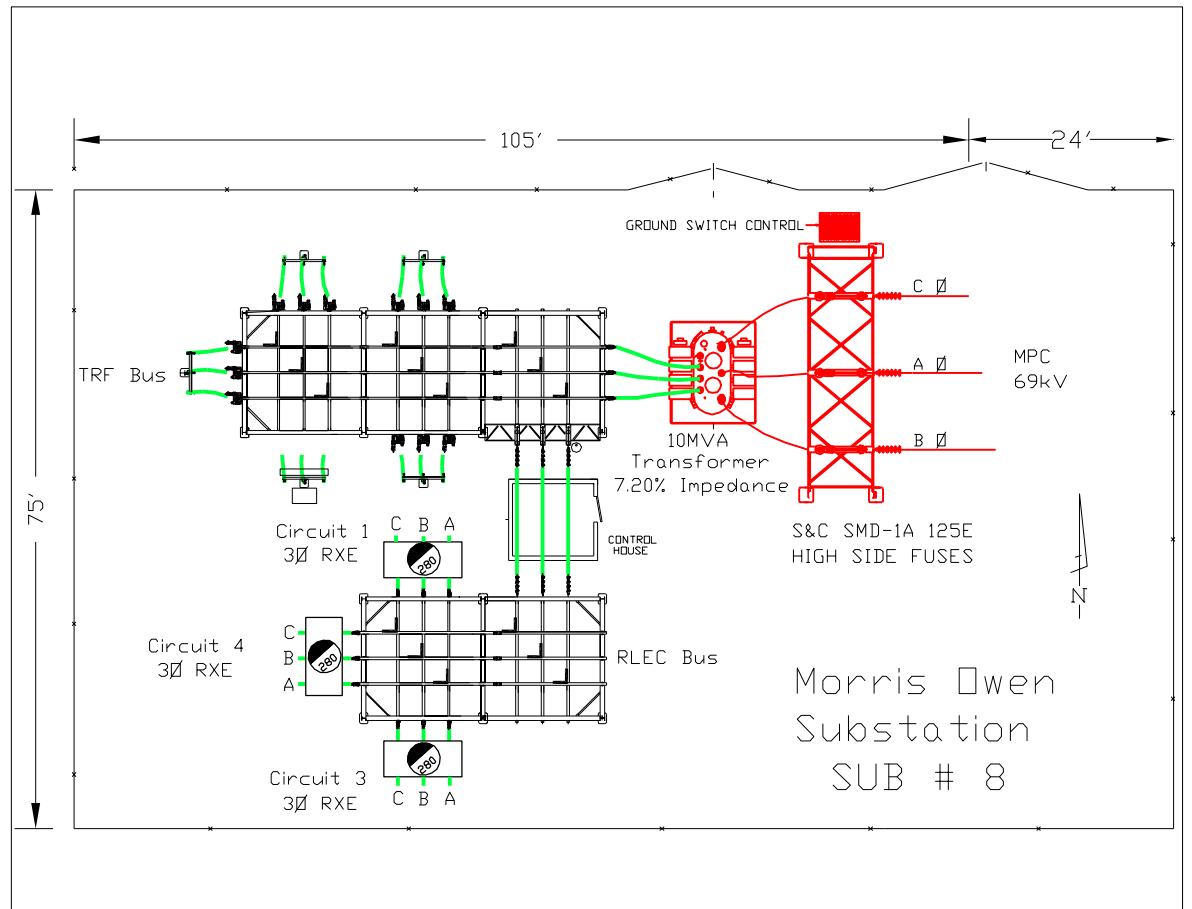
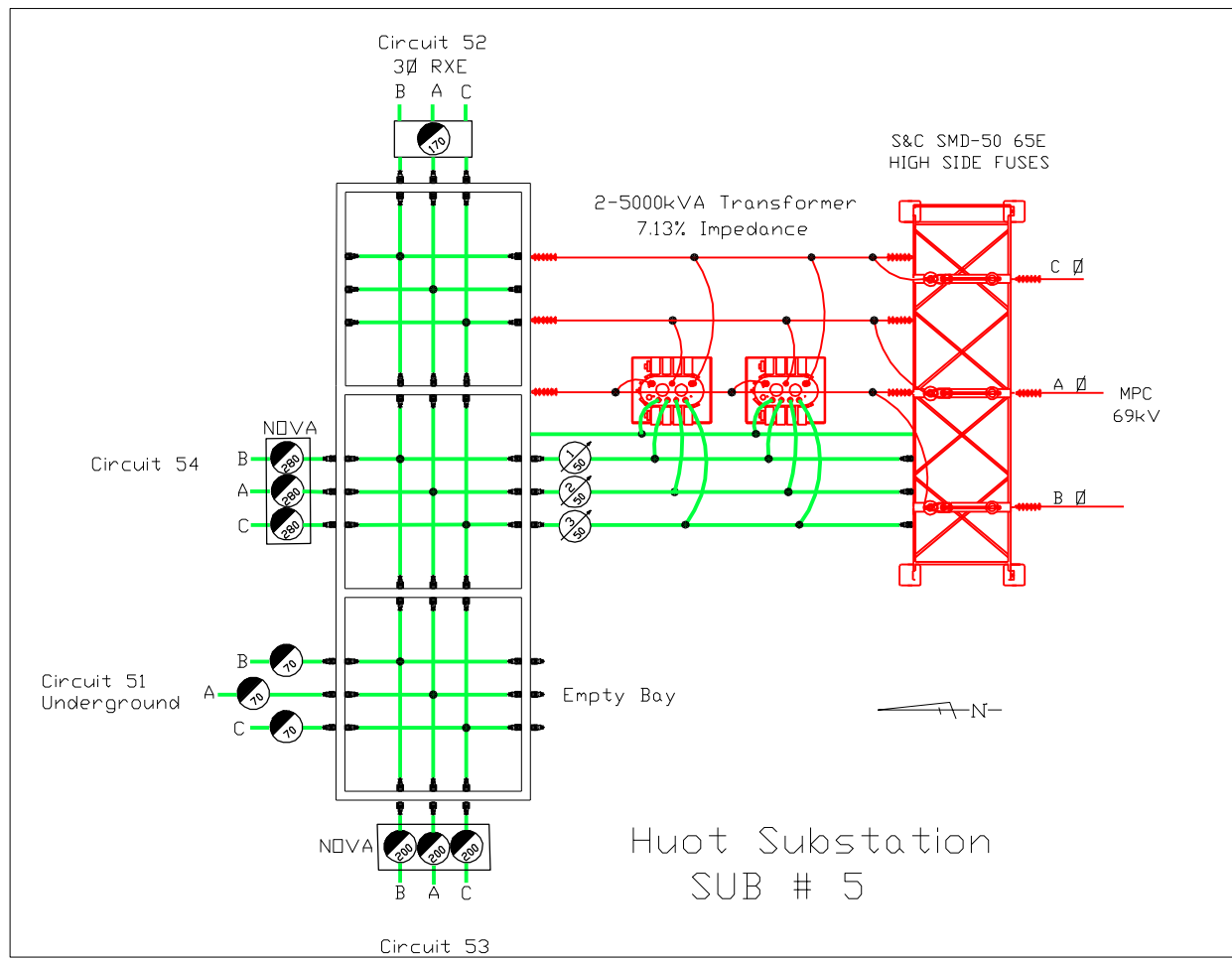

RED LAKE ELECTRIC COOP

RED LAKE FALLS, MN

DWN: STEVE CONELY 4/9/02 REV: Chris 10/11/2017

SUBSTATION DRAWINGS

Gentilly Creek Substation

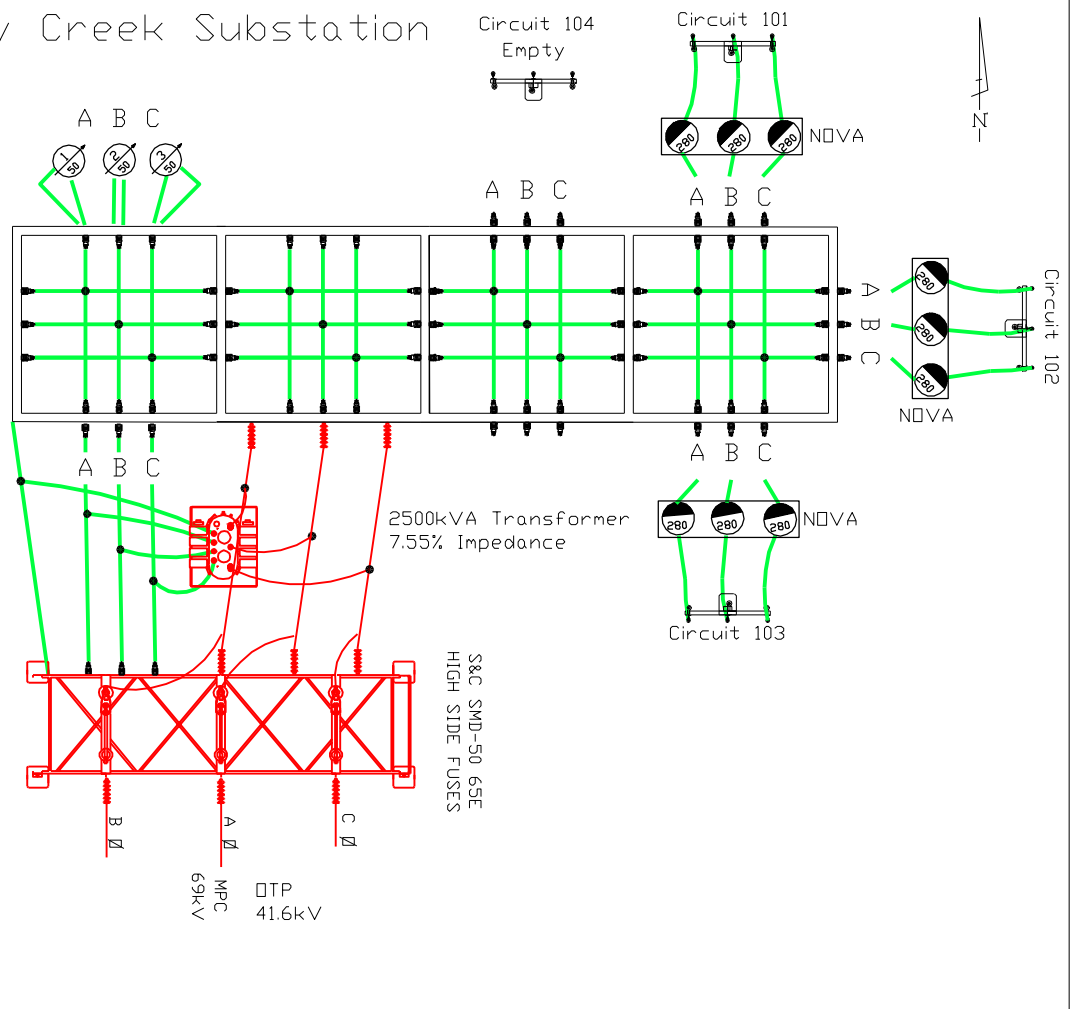

	RED LAKE ELECTRIC COOP	
	RED LAKE FALLS, MN	
	DWN: STEVE CONELY 4/9/02	REV: Chris 10/11/2017
SUBSTATION DRAWINGS		

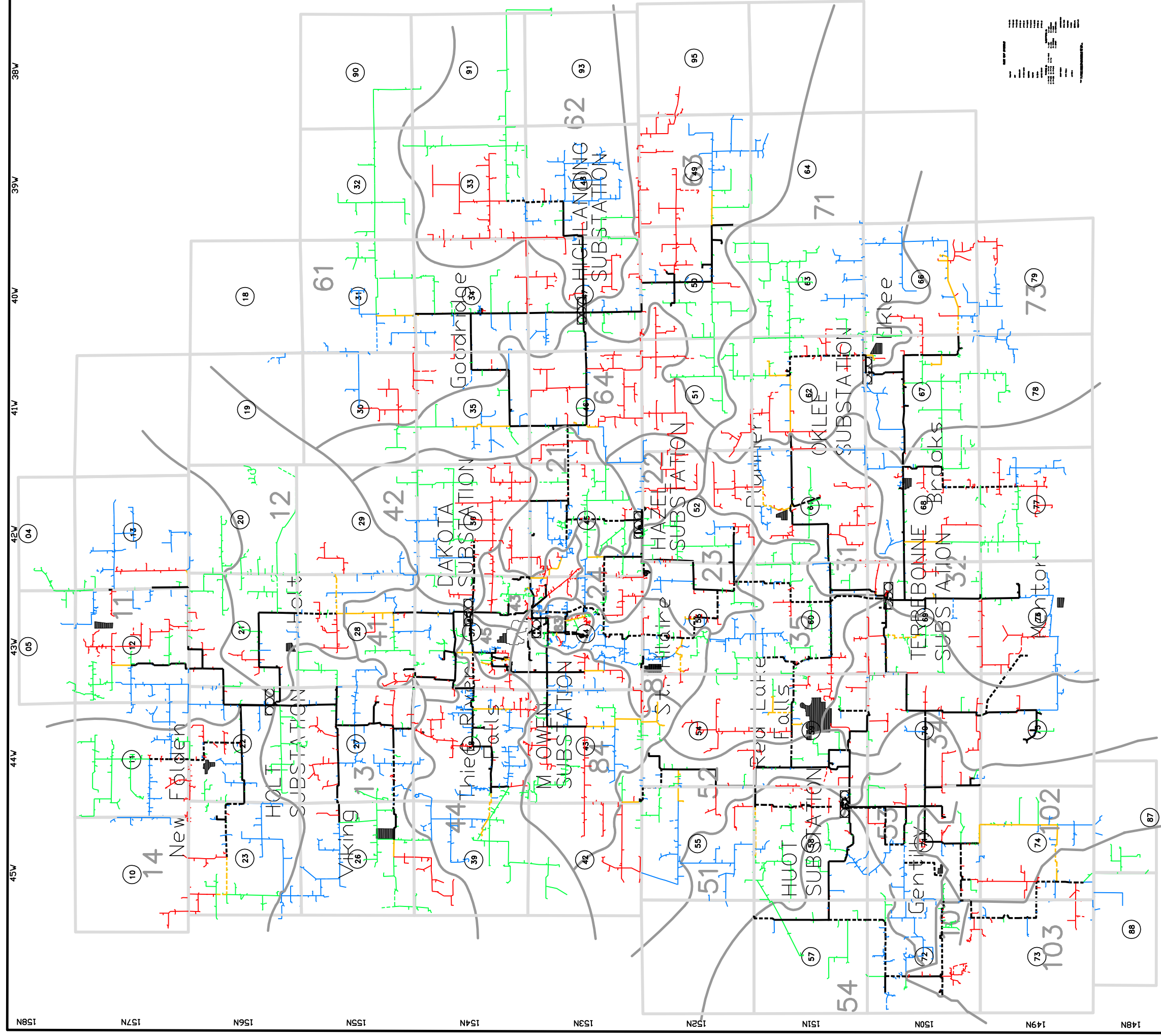

Red Lake Electric Coop., Inc
Red Lake Falls, Minnesota
Minnesota 75 Red Lake

Red Lake Electric Coop., Inc.
Red Lake Falls, Minnesota
Minnesota 75 Red Lake

INSPECTION
DATE:

- OSMOSE
- LINE CREW
- MEMBER SERVICES

MAP NO.

F012

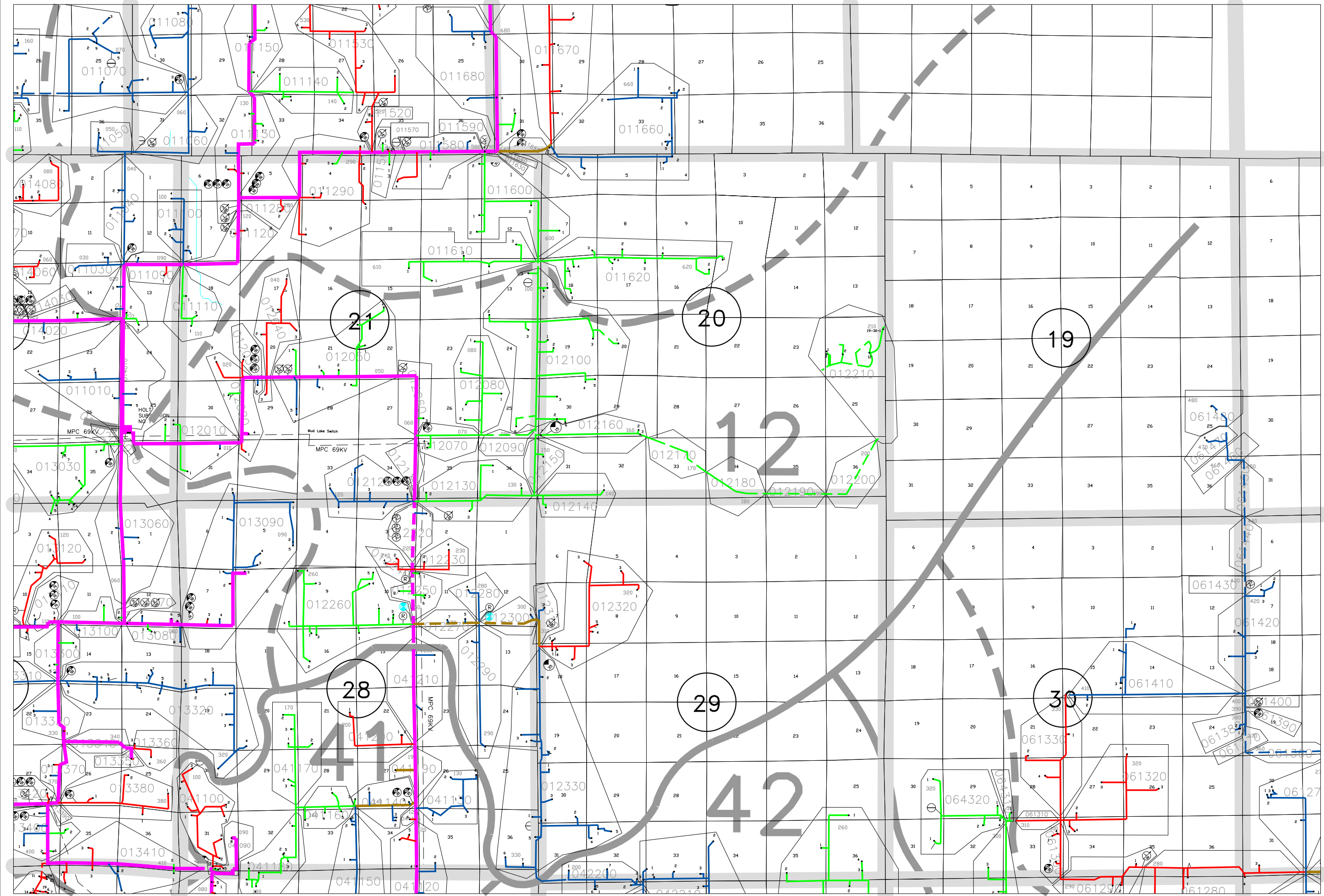

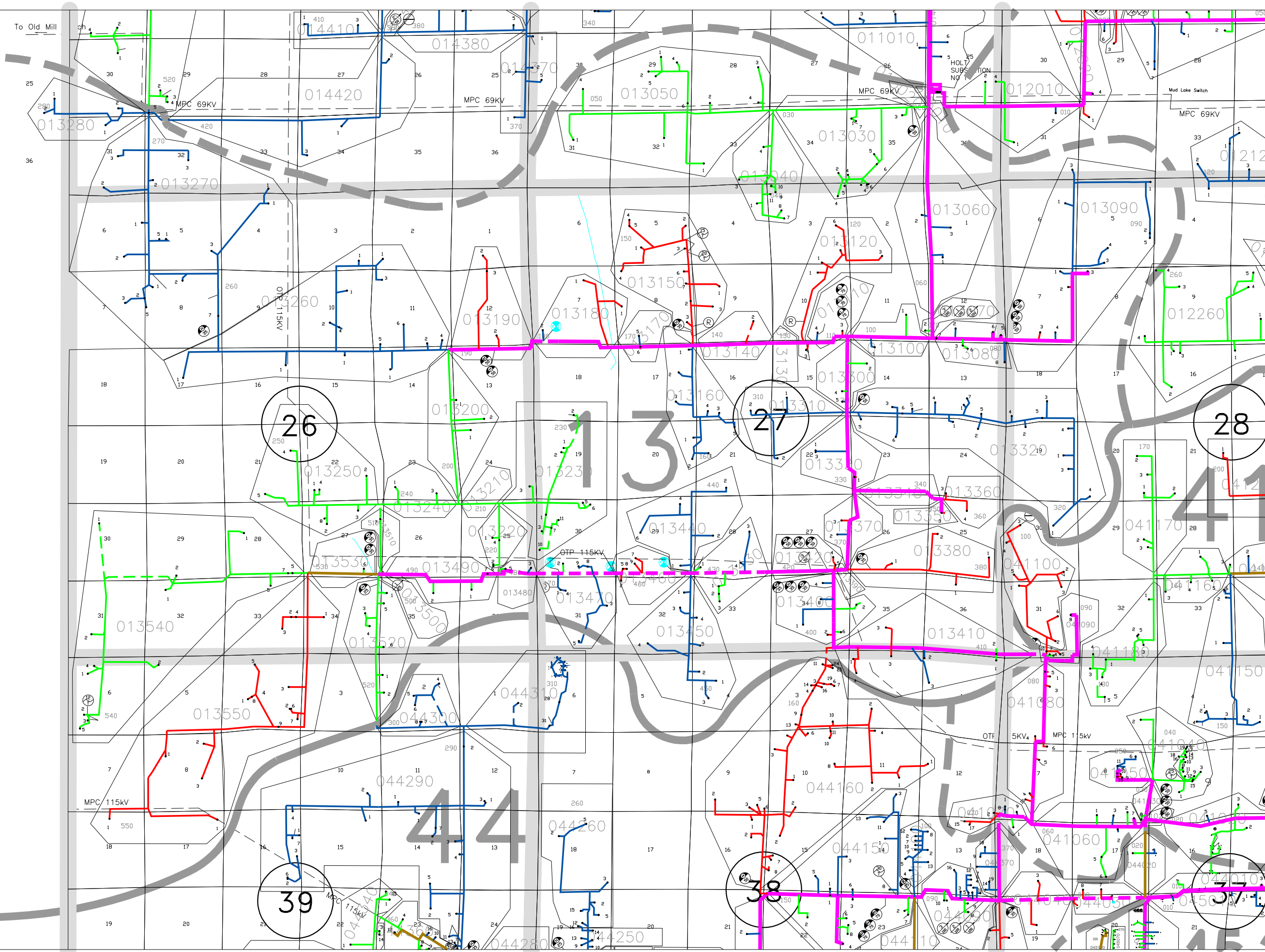

Red Lake Electric Coop., Inc.
 Red Lake Falls, Minnesota
 Minnesota 75 Red Lake

INSPECTION
 DATE:

- OSMOSE
- LINE CREW
- MEMBER SERVICES

MAP NO.
F013

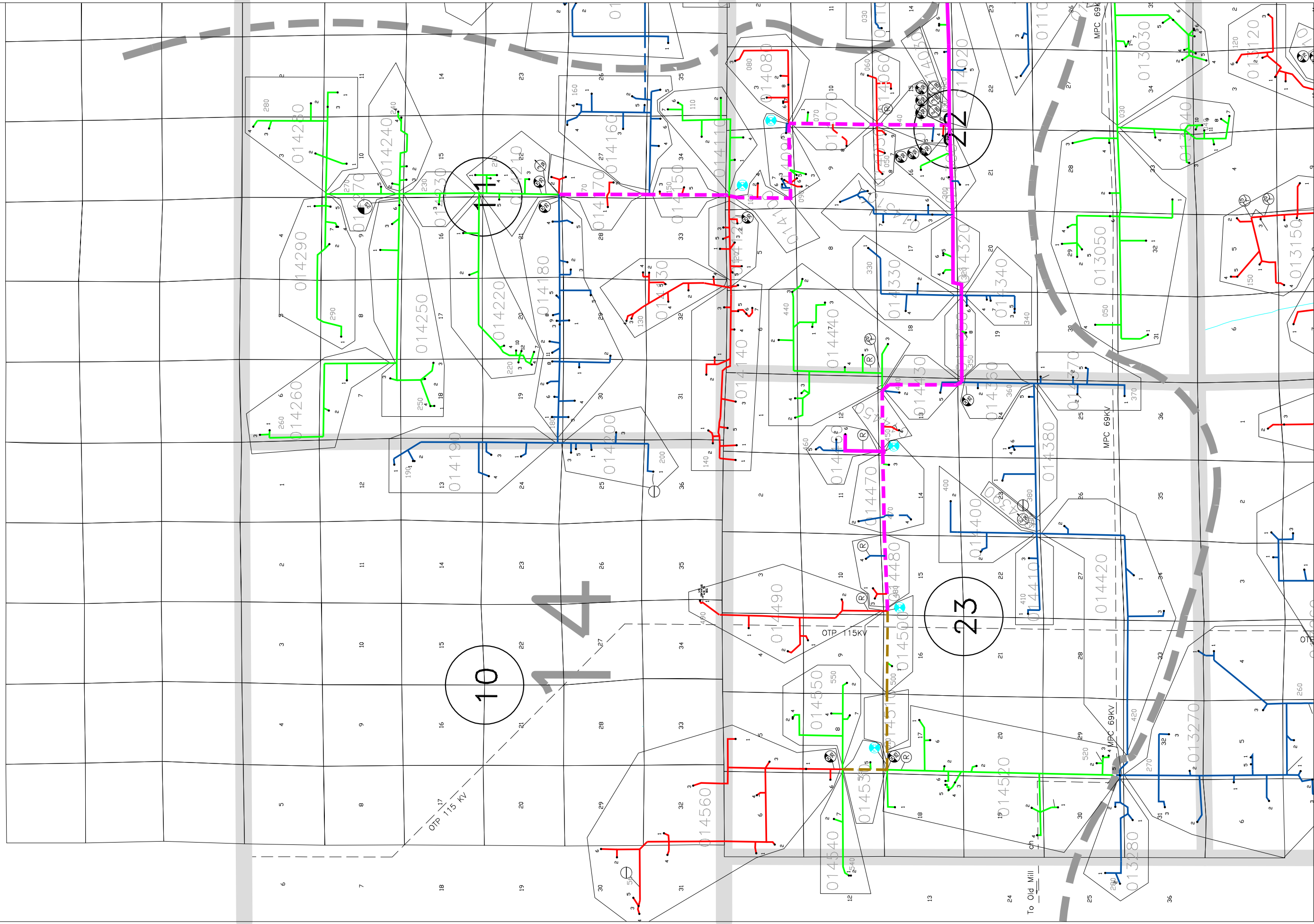

Red Lake Electric Coop., Inc.
 Red Lake Falls, Minnesota
 Minnesota 75 Red Lake

INSPECTION
 DATE:

- OSMOSE
- LINE CREW
- MEMBER SERVICES

MAP NO.
F014

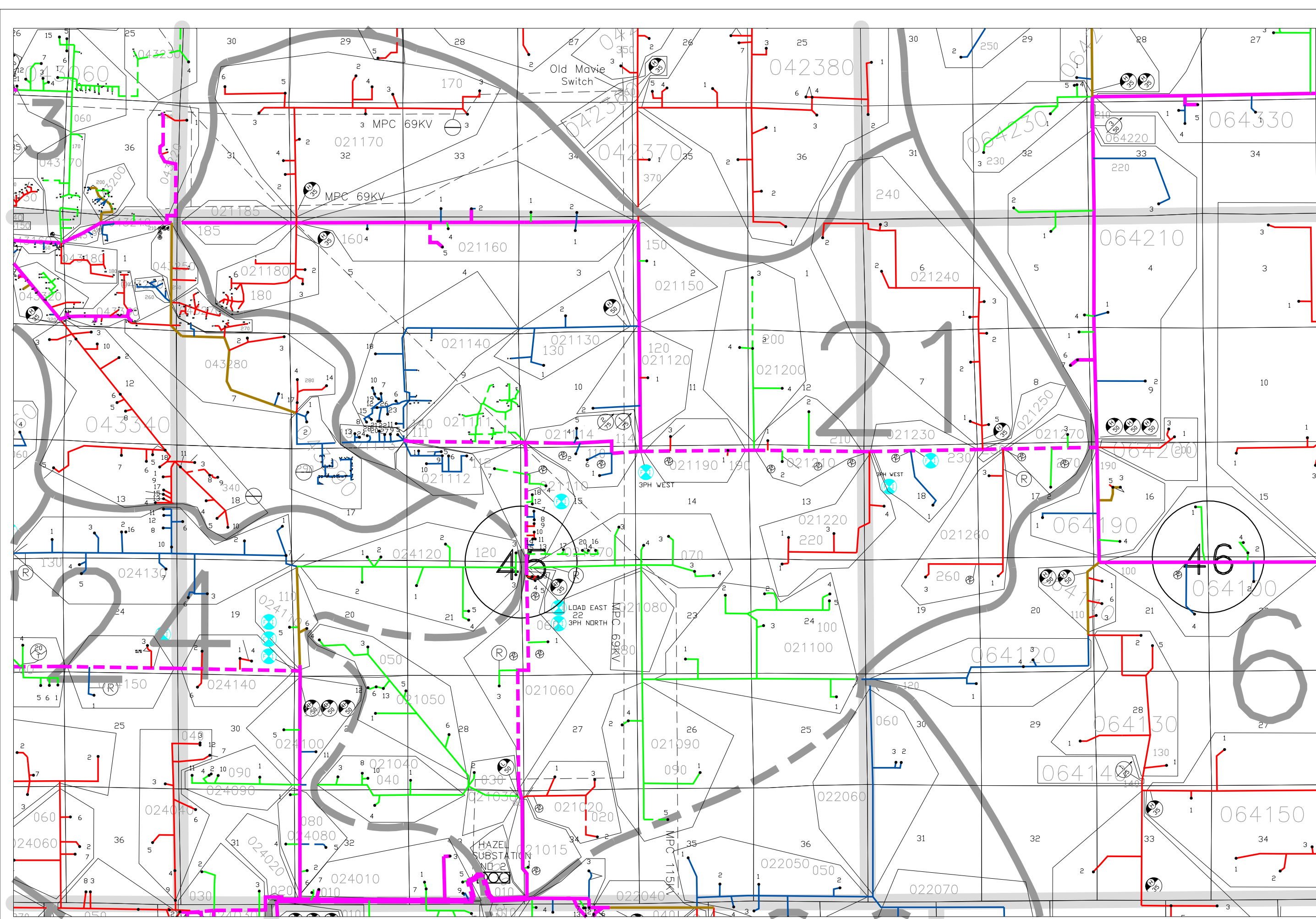

Red Lake Electric Coop., Inc.
 Red Lake Falls, Minnesota
 Minnesota 75 Red Lake

INSPECTION
 DATE:

- OSMOSE
- LINE CREW
- MEMBER SERVICES

MAP NO.
F021

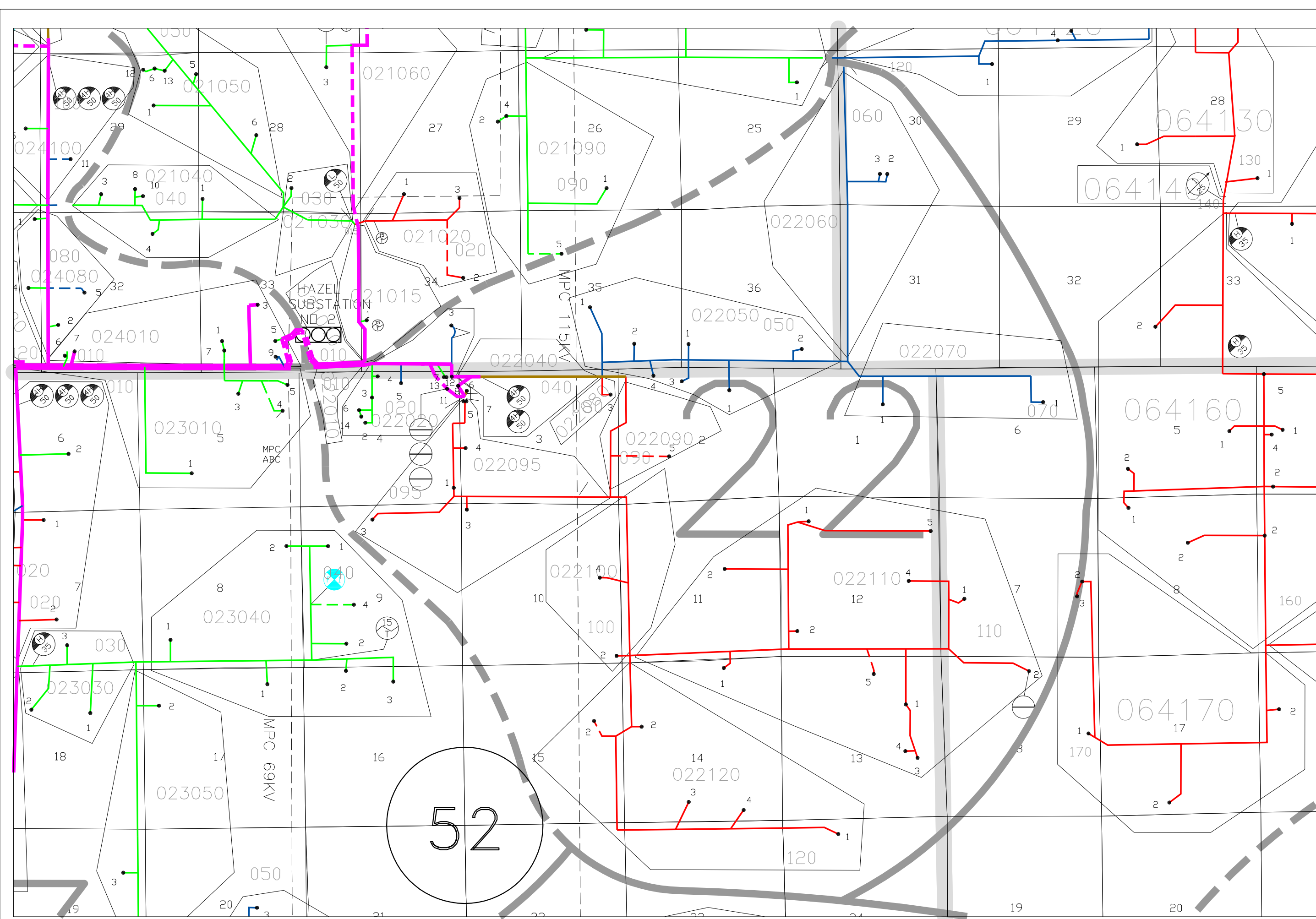

Red Lake Electric Coop., Inc.
 Red Lake Falls, Minnesota
 Minnesota 75 Red Lake

INSPECTION
 DATE:

- OSMOSE
- LINE CREW
- MEMBER SERVICES

MAP NO.
F022

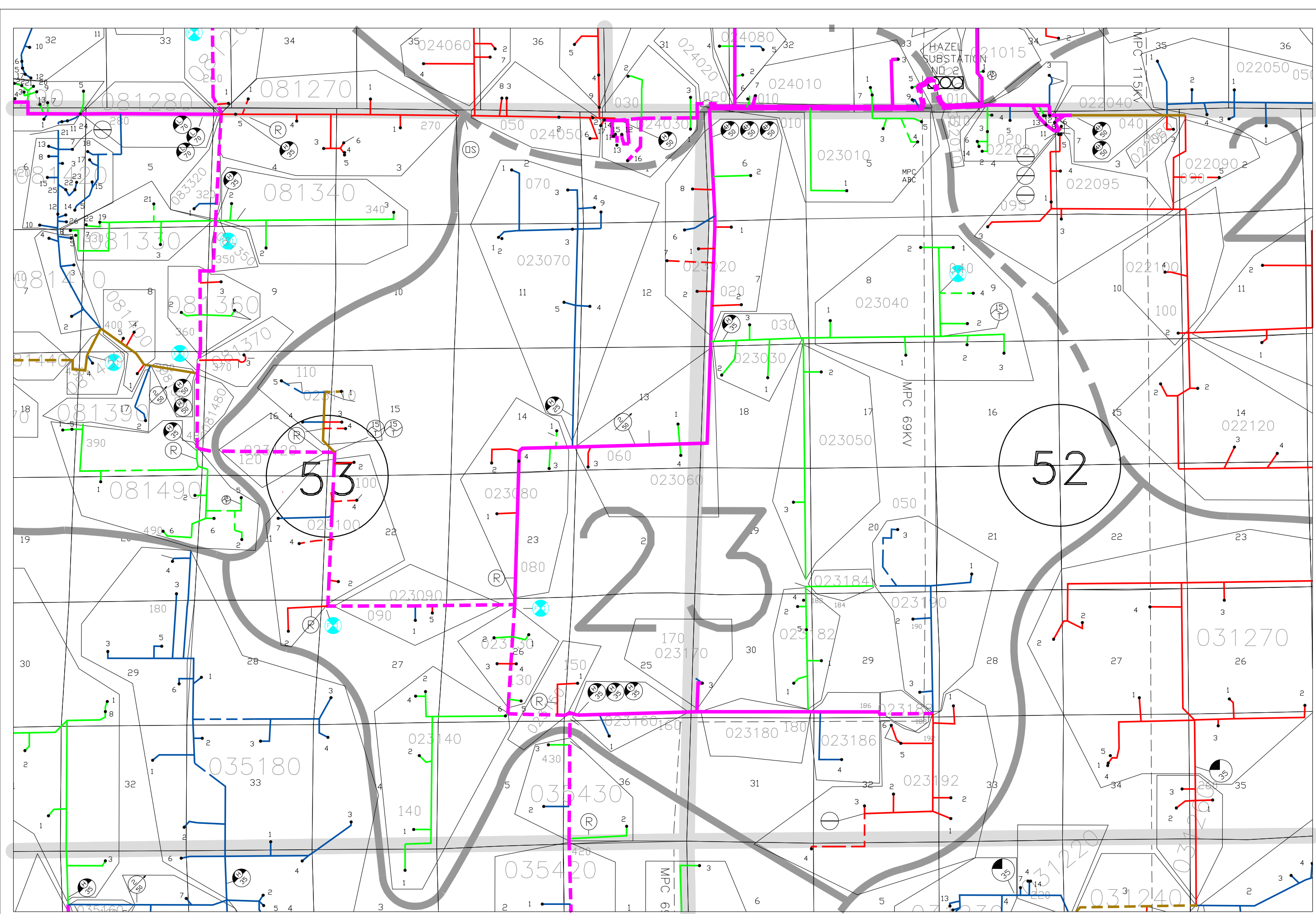

Red Lake Electric Coop., Inc.
 Red Lake Falls, Minnesota
 Minnesota 75 Red Lake

INSPECTION
 DATE:

- OSMOSE
- LINE CREW
- MEMBER SERVICES

MAP NO.
F023

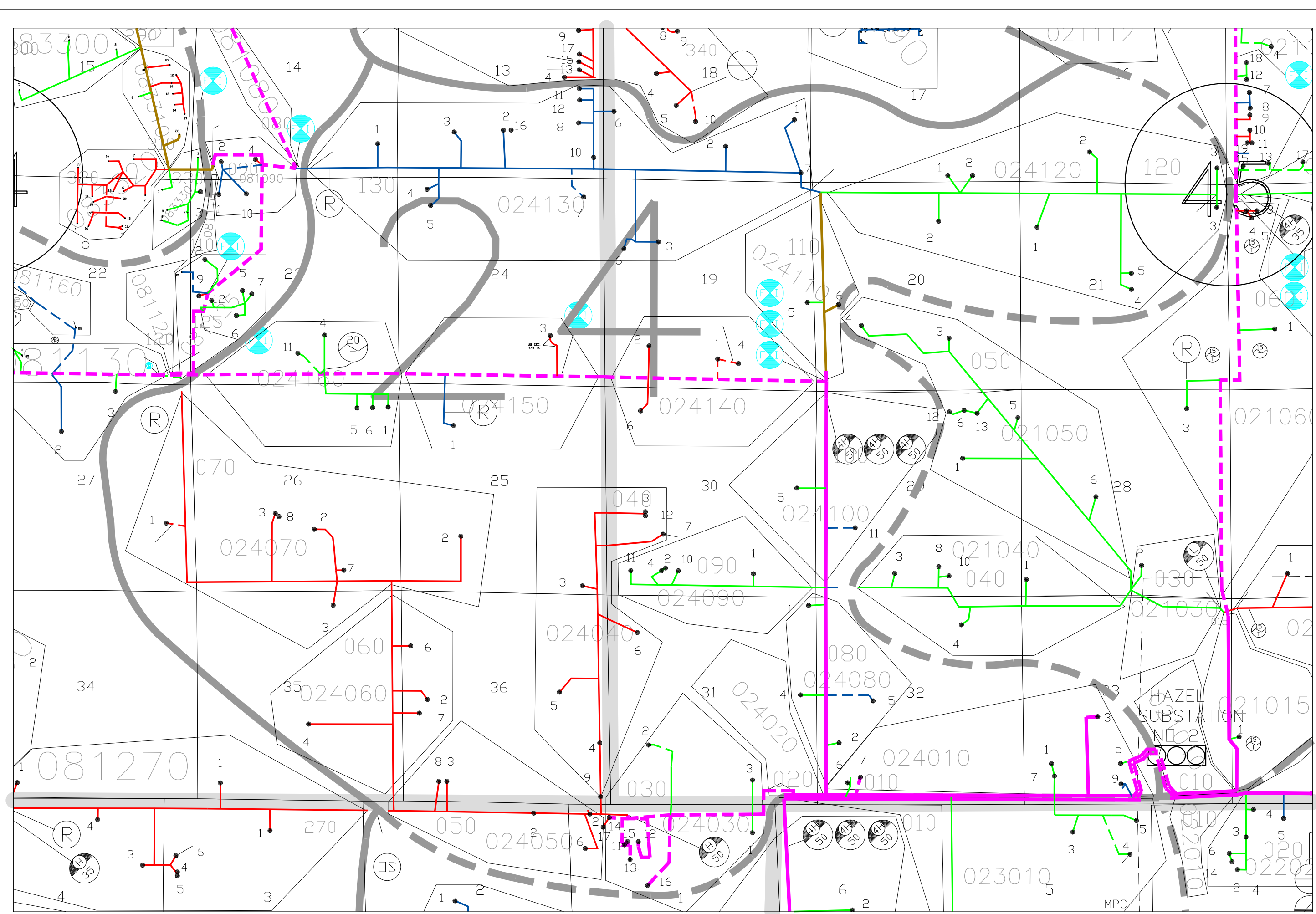

Red Lake Electric Coop., Inc.
 Red Lake Falls, Minnesota
 Minnesota 75 Red Lake

INSPECTION
 DATE:

- OSMOSE
- LINE CREW
- MEMBER SERVICES

MAP NO.
F024

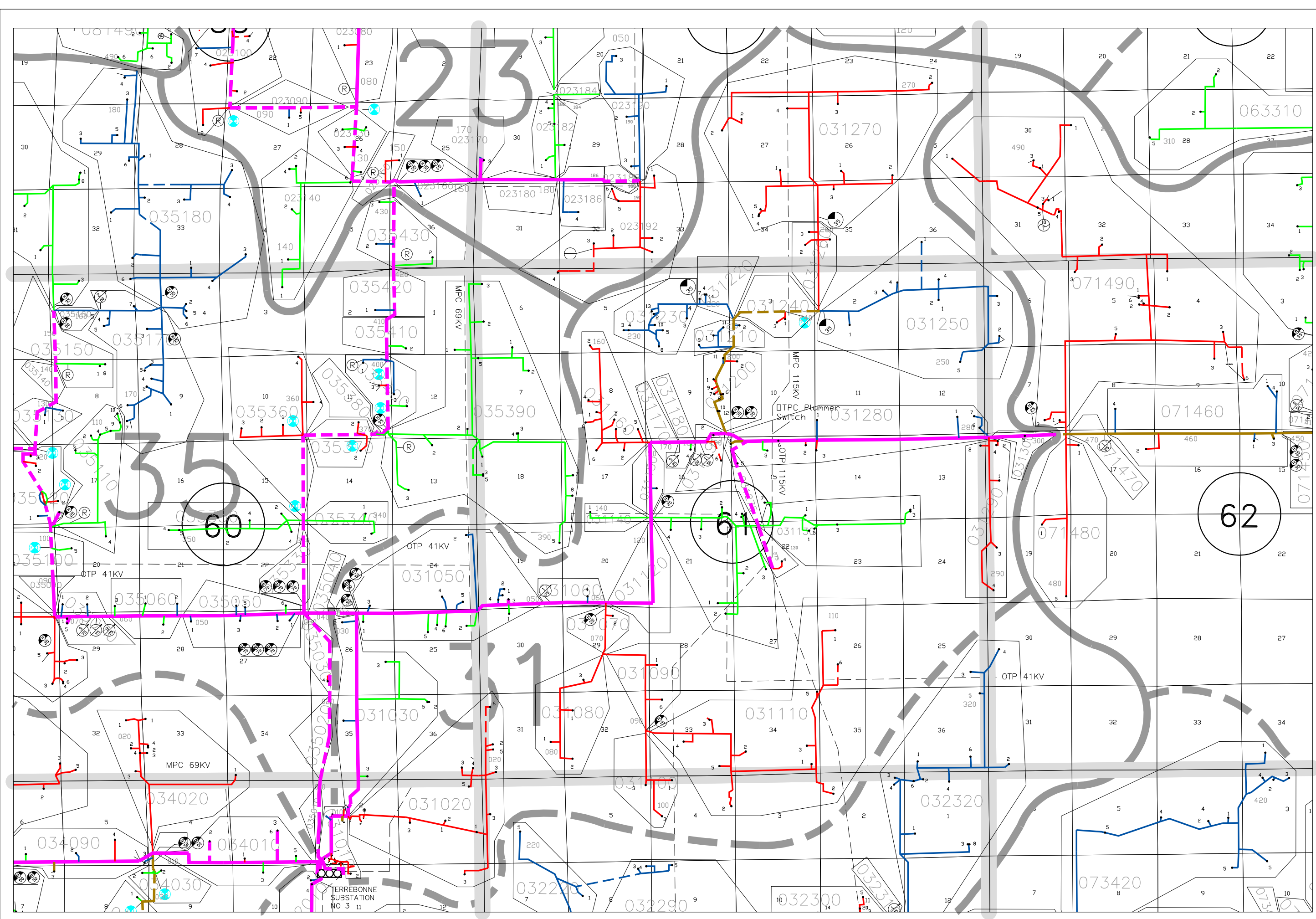

Red Lake Electric Coop., Inc.
 Red Lake Falls, Minnesota
 Minnesota 75 Red Lake

INSPECTION
 DATE:

- OSMOSE
- LINE CREW
- MEMBER SERVICES

MAP NO.
F031

Red Lake Electric Coop., Inc.
Red Lake Falls, Minnesota
Minnesota 75 Red Lake

INSPECTION
DATE:

- OSMOSE
- LINE CREW
- MEMBER SERVICES

MAP NO.

F032

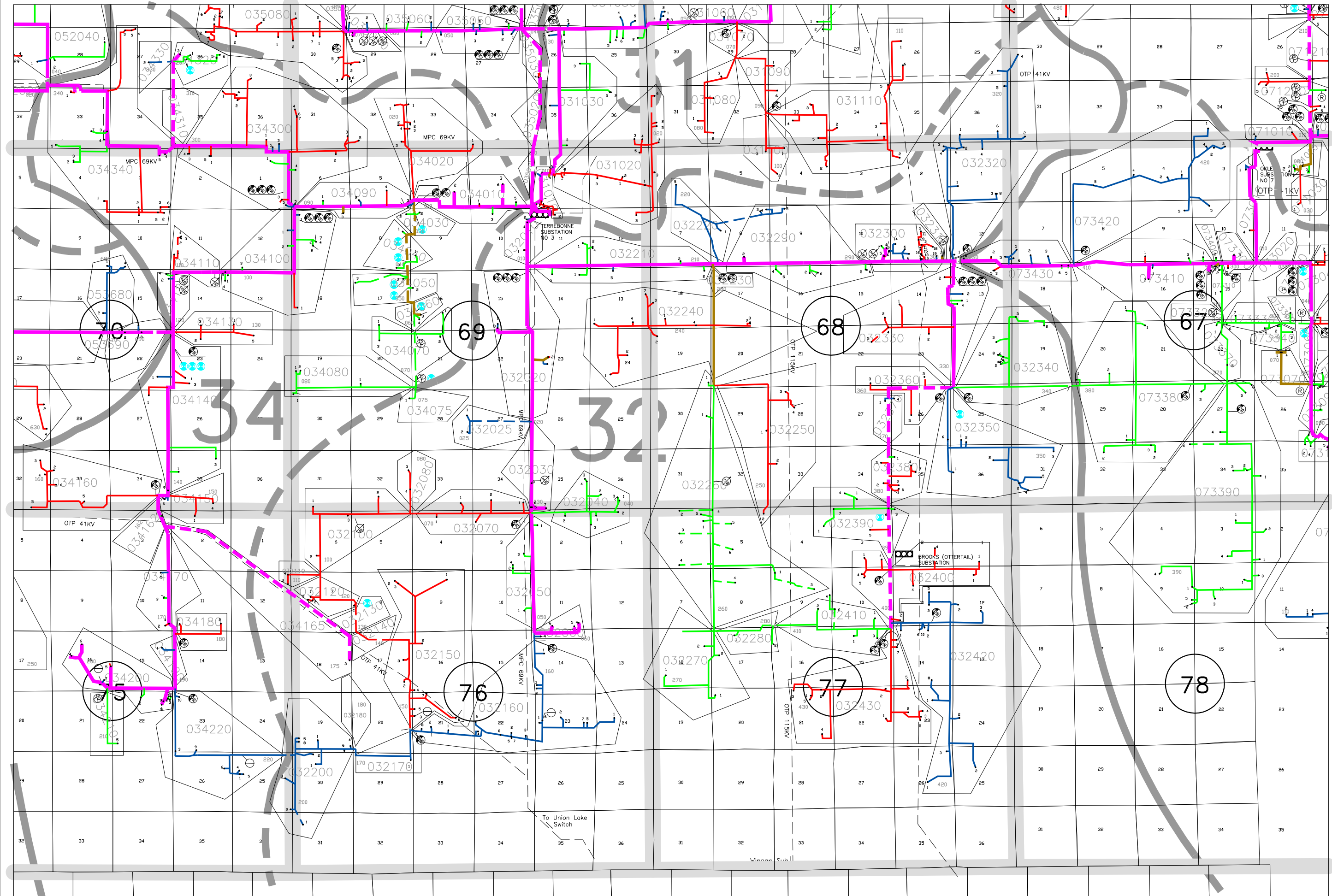

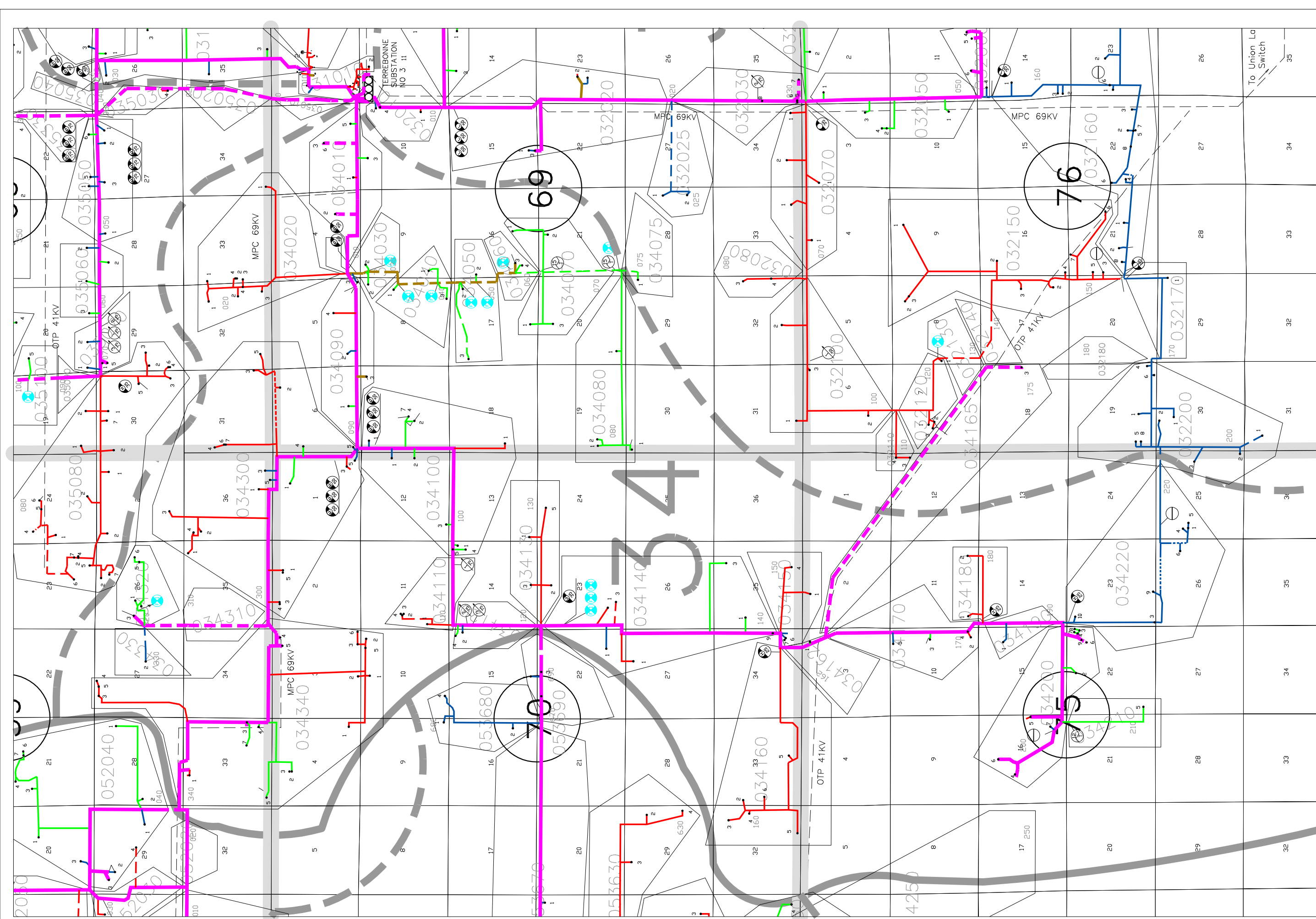

Red Lake Electric Coop., Inc.
 Red Lake Falls, Minnesota
 Minnesota 75 Red Lake

INSPECTION
 DATE:

- OSMOSE
- LINE CREW
- MEMBER SERVICES

MAP NO.
F034

Red Lake Electric Coop., Inc.
Red Lake Falls, Minnesota
Minnesota 75 Red Lake

INSPECTION
DATE:

- OSMOSE
- LINE CREW
- MEMBER SERVICES

MAP NO.

F035

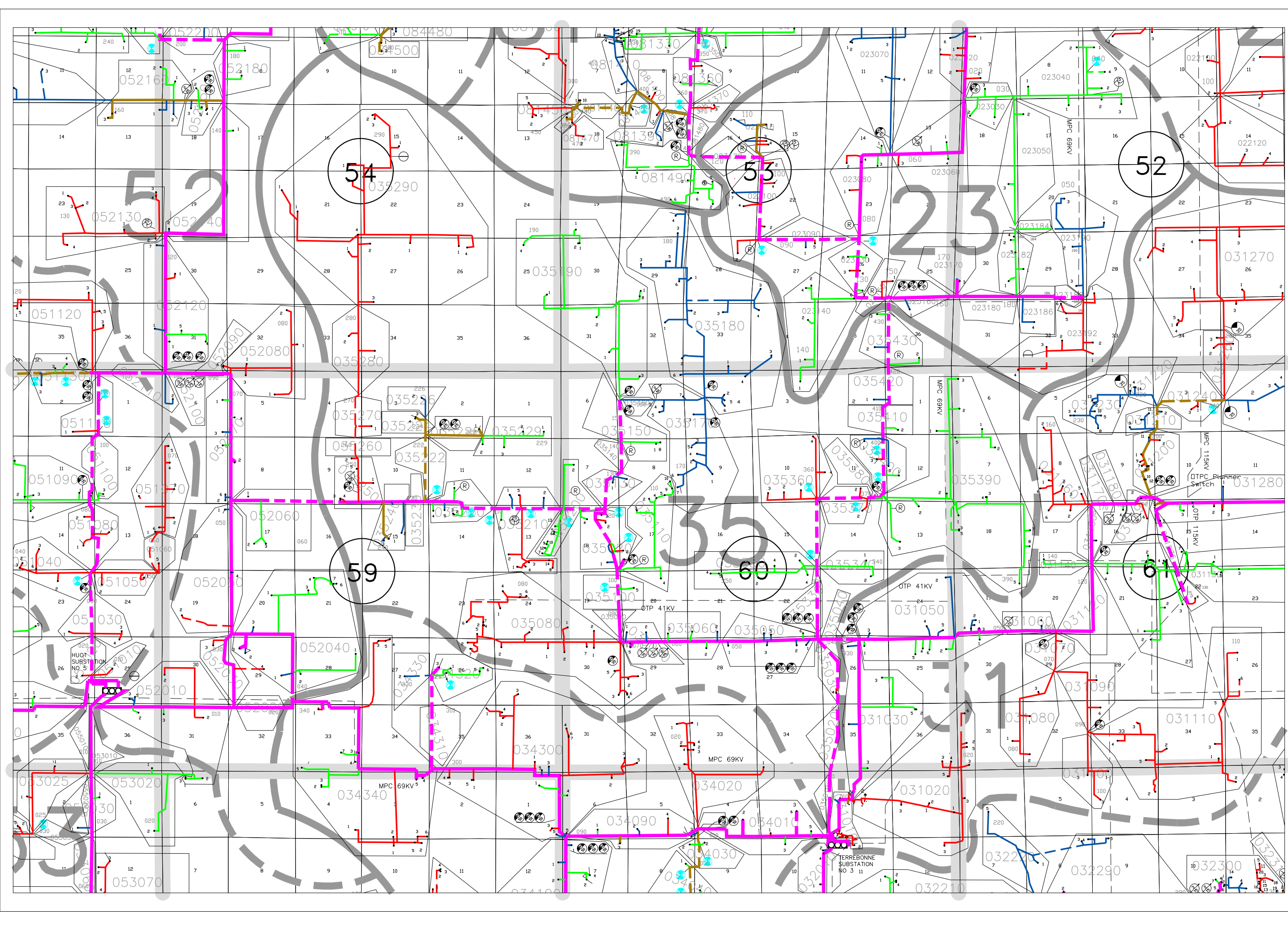

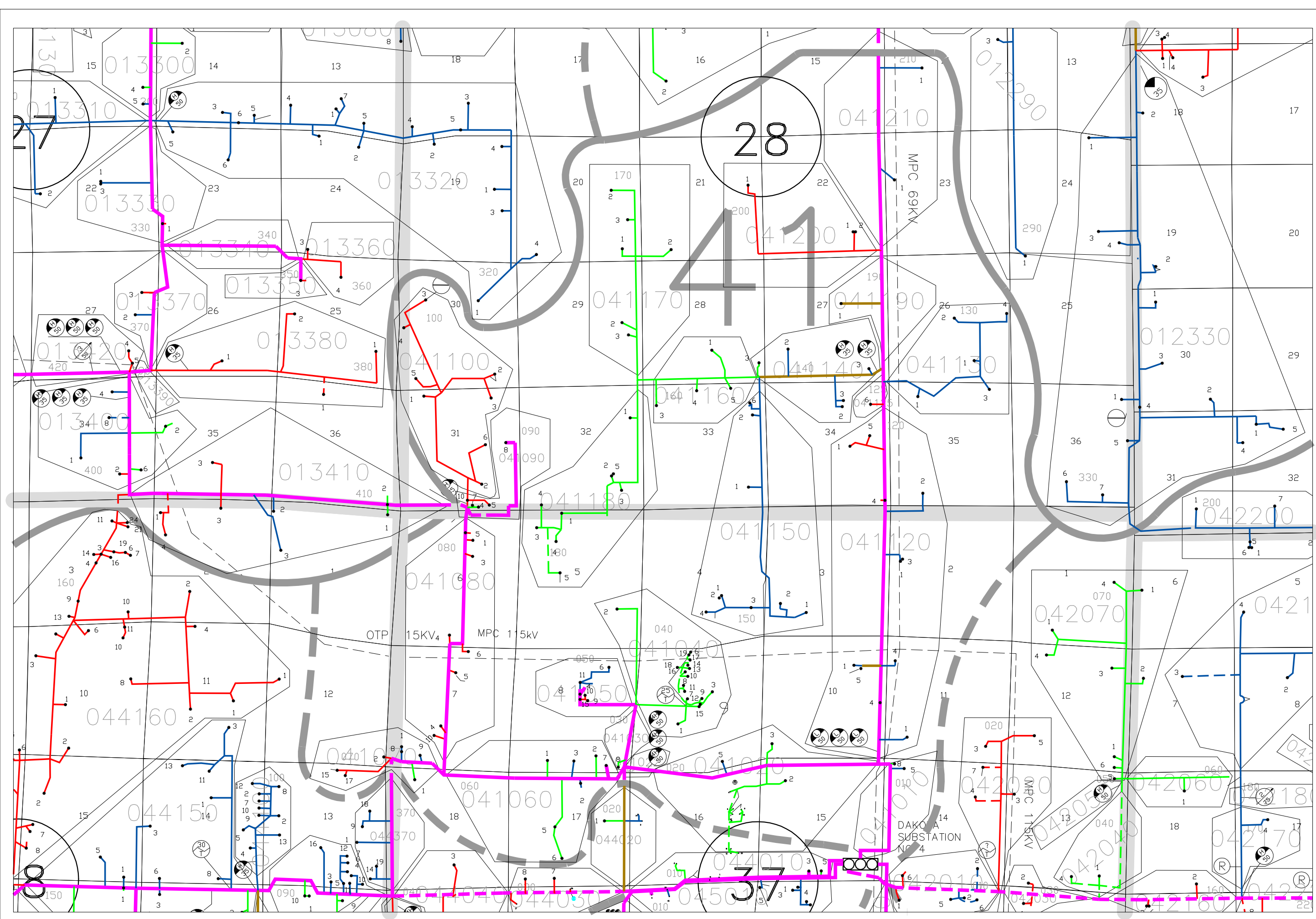

Red Lake Electric Coop., Inc.
 Red Lake Falls, Minnesota
 Minnesota 75 Red Lake

INSPECTION
 DATE:

- OSMOSE
- LINE CREW
- MEMBER SERVICES

MAP NO.
F041

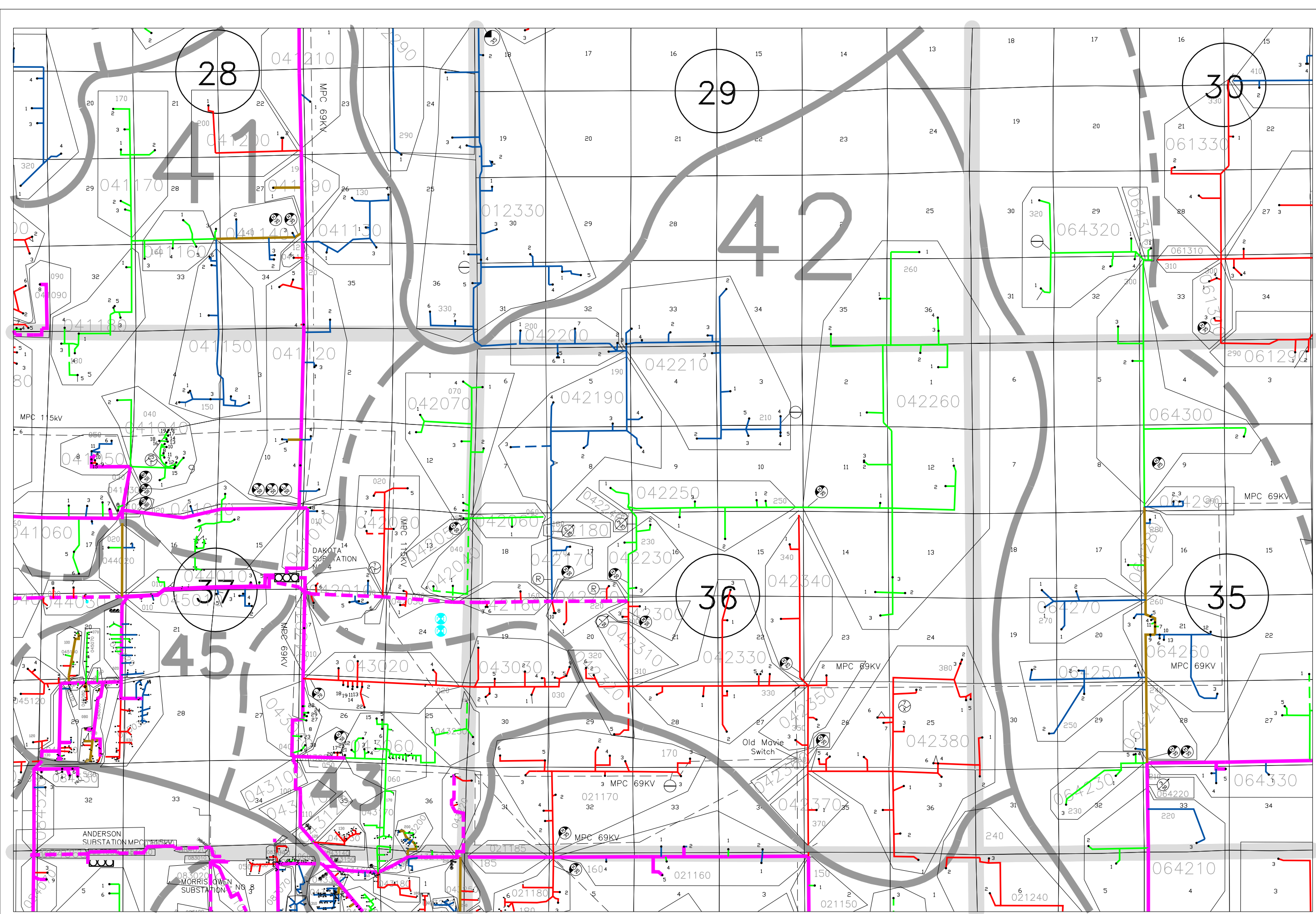

Red Lake Electric Coop., Inc.
 Red Lake Falls, Minnesota
 Minnesota 75 Red Lake

INSPECTION
 DATE:

- OSMOSE
- LINE CREW
- MEMBER SERVICES

MAP NO.
F042

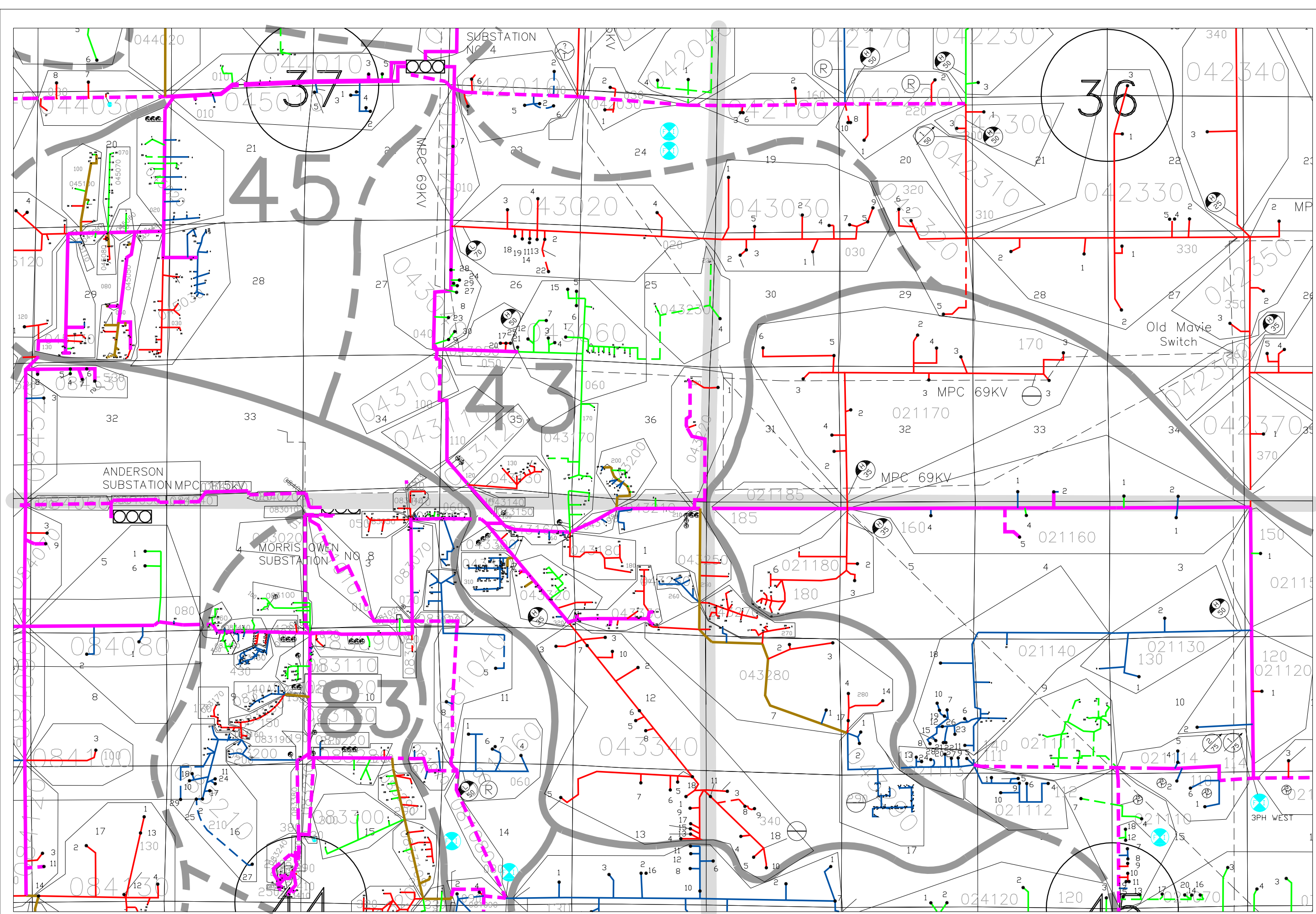

Red Lake Electric Coop., Inc.
 Red Lake Falls, Minnesota
 Minnesota 75 Red Lake

INSPECTION
 DATE:

- OSMOSE
- LINE CREW
- MEMBER SERVICES

MAP NO.

F043

Red Lake Electric Coop., Inc.
Red Lake Falls, Minnesota
Minnesota 75 Red Lake

INSPECTION
DATE:

- OSMOSE
- LINE CREW
- MEMBER SERVICES

MAP NO.

F044

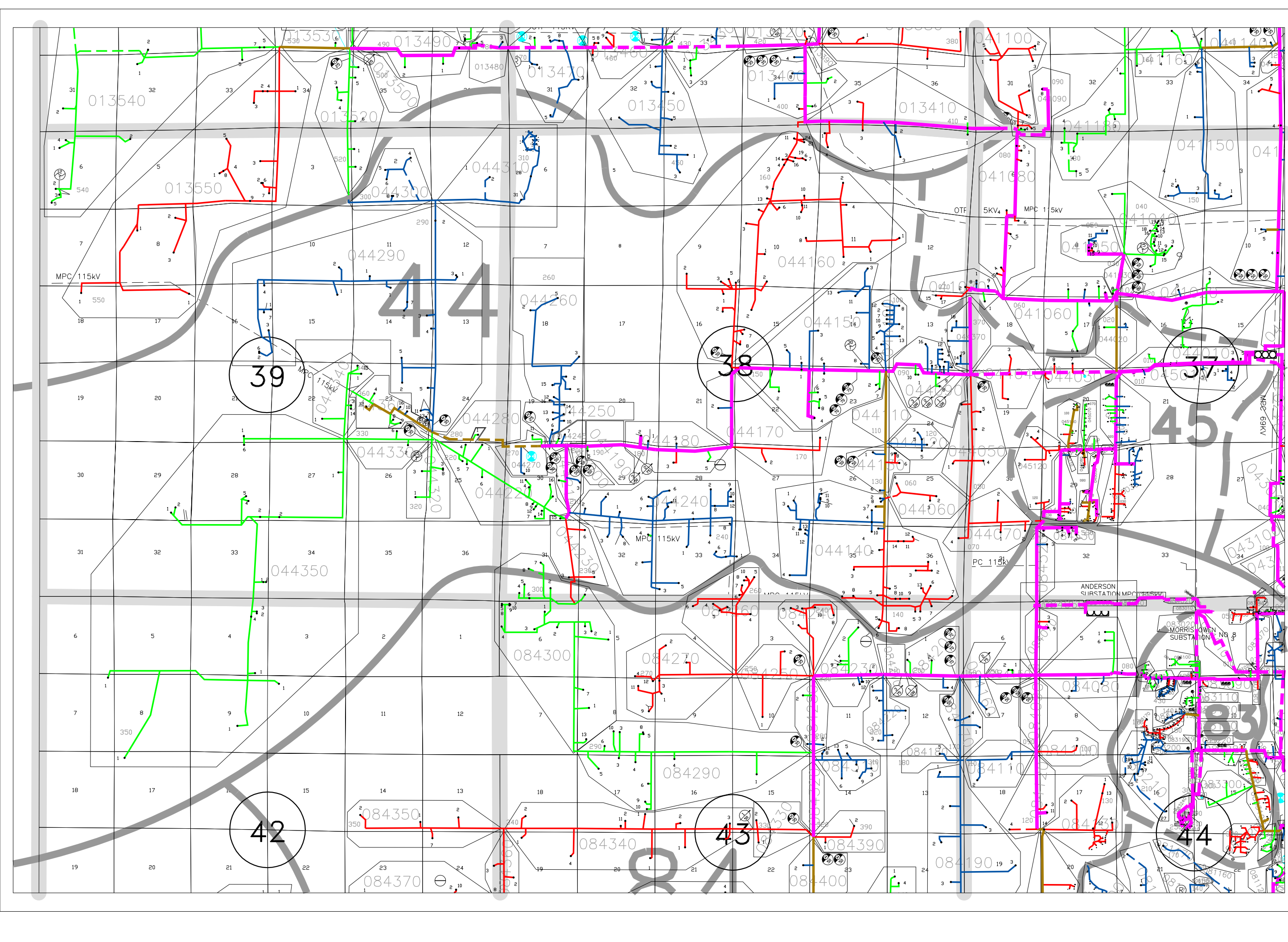

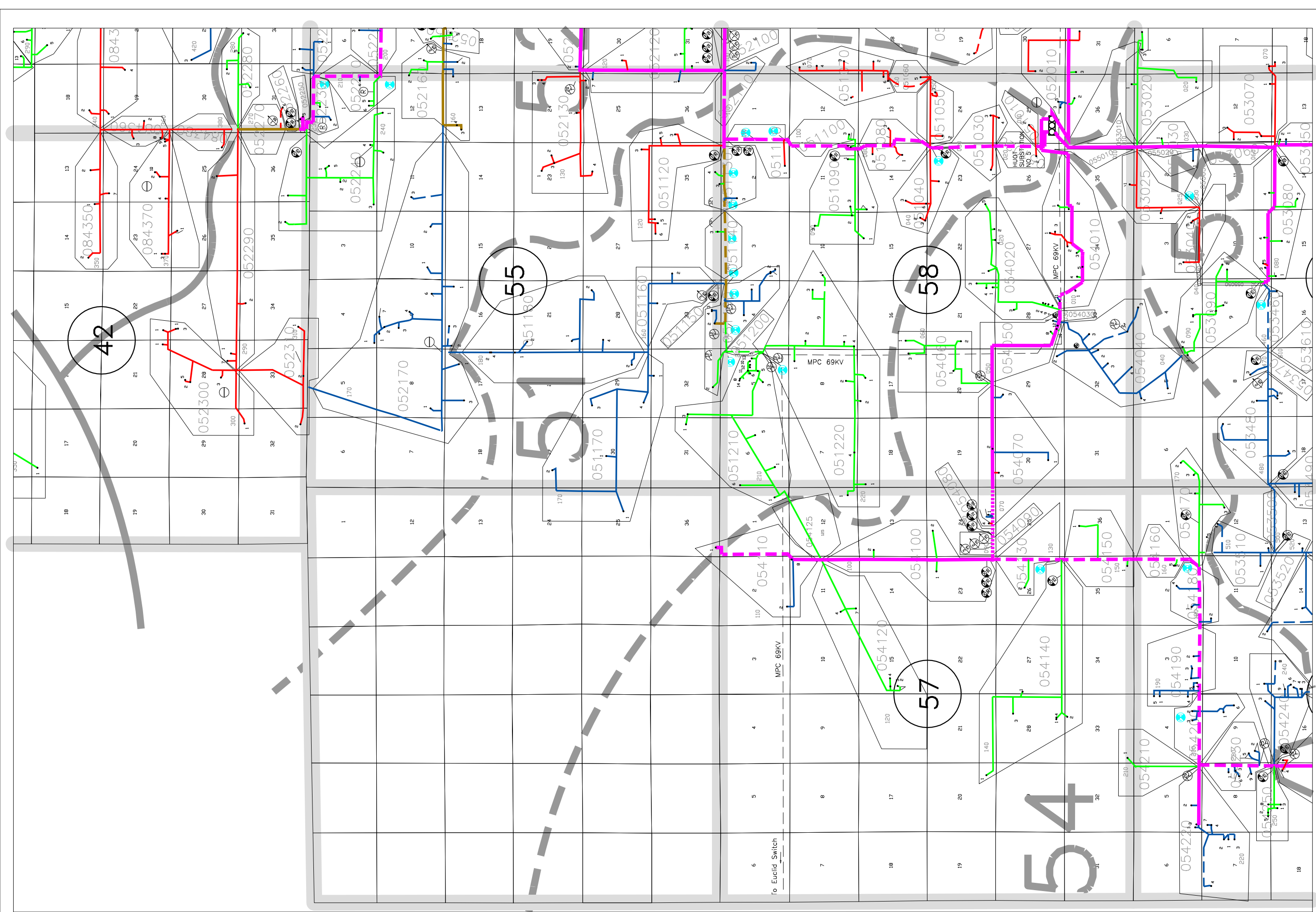

Red Lake Electric Coop., Inc.
 Red Lake Falls, Minnesota
 Minnesota 75 Red Lake

INSPECTION
 DATE:

- OSMOSE
- LINE CREW
- MEMBER SERVICES

MAP NO.

F051

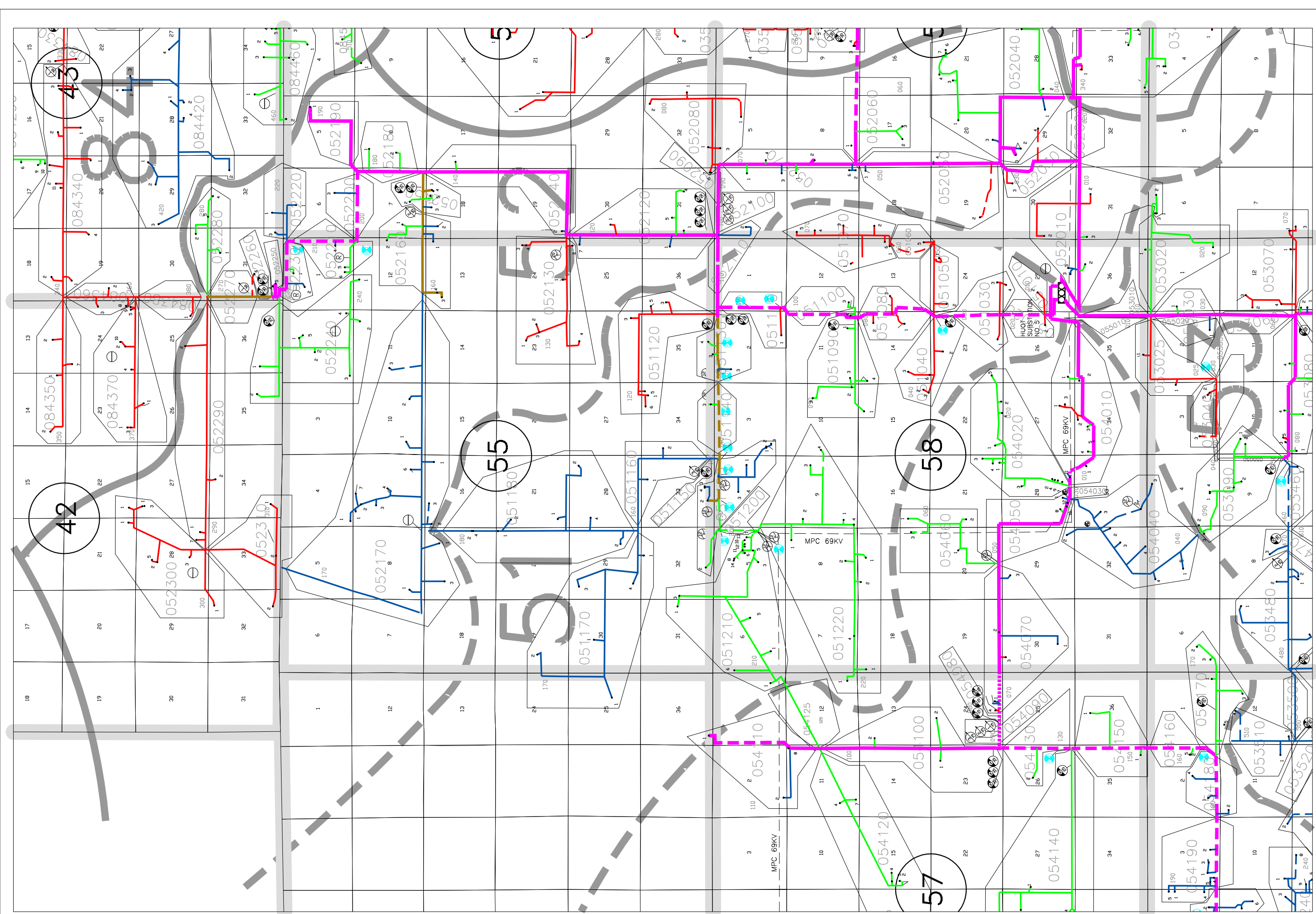

Red Lake Electric Coop., Inc.
 Red Lake Falls, Minnesota
 Minnesota 75 Red Lake

INSPECTION
 DATE:

- OSMOSE
- LINE CREW
- MEMBER SERVICES

MAP NO.
F052

Red Lake Electric Coop., Inc.
Red Lake Falls, Minnesota
Minnesota 75 Red Lake

INSPECTION
DATE:

- OSMOSE
- LINE CREW
- MEMBER SERVICES

MAP NO.

F053

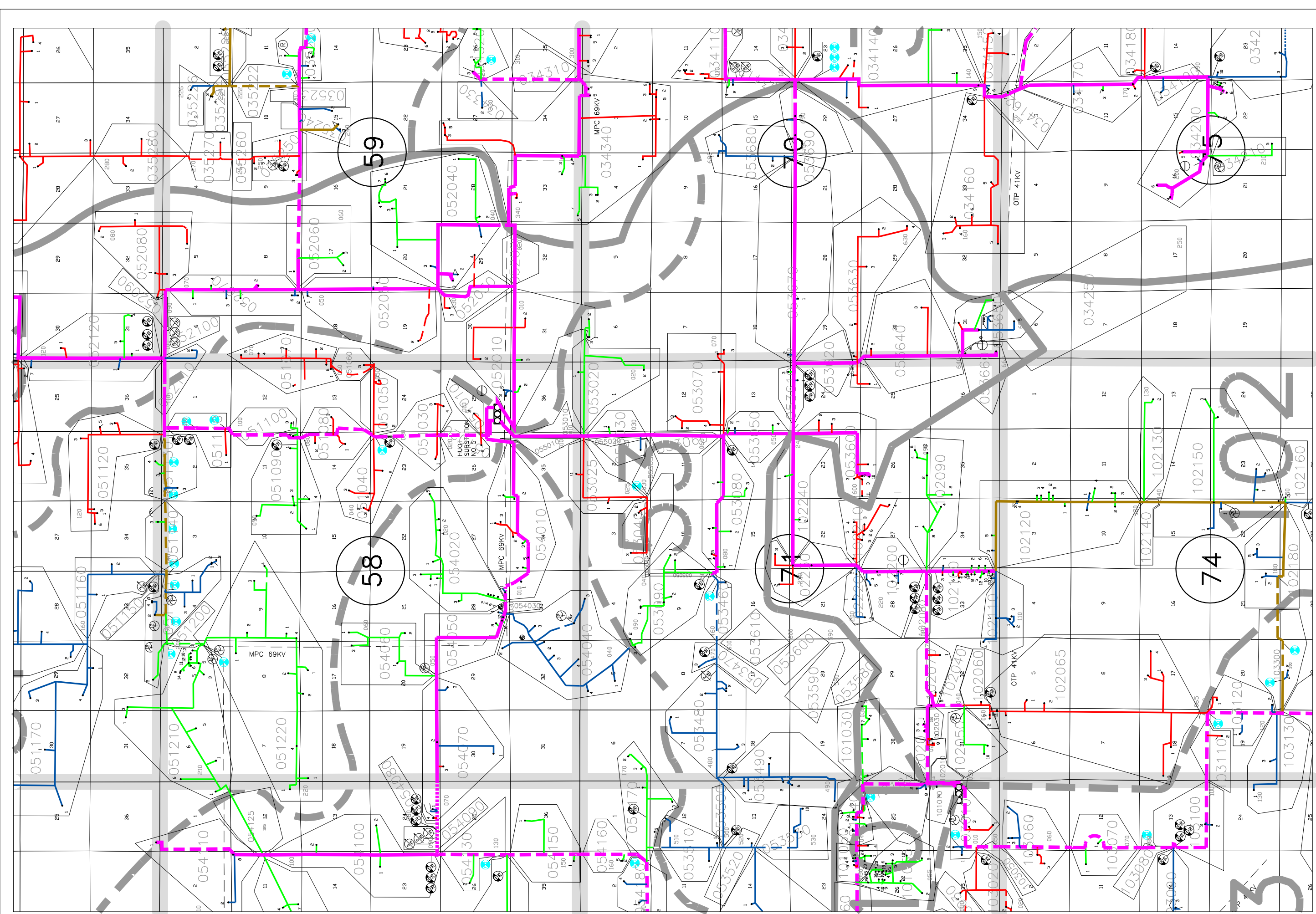

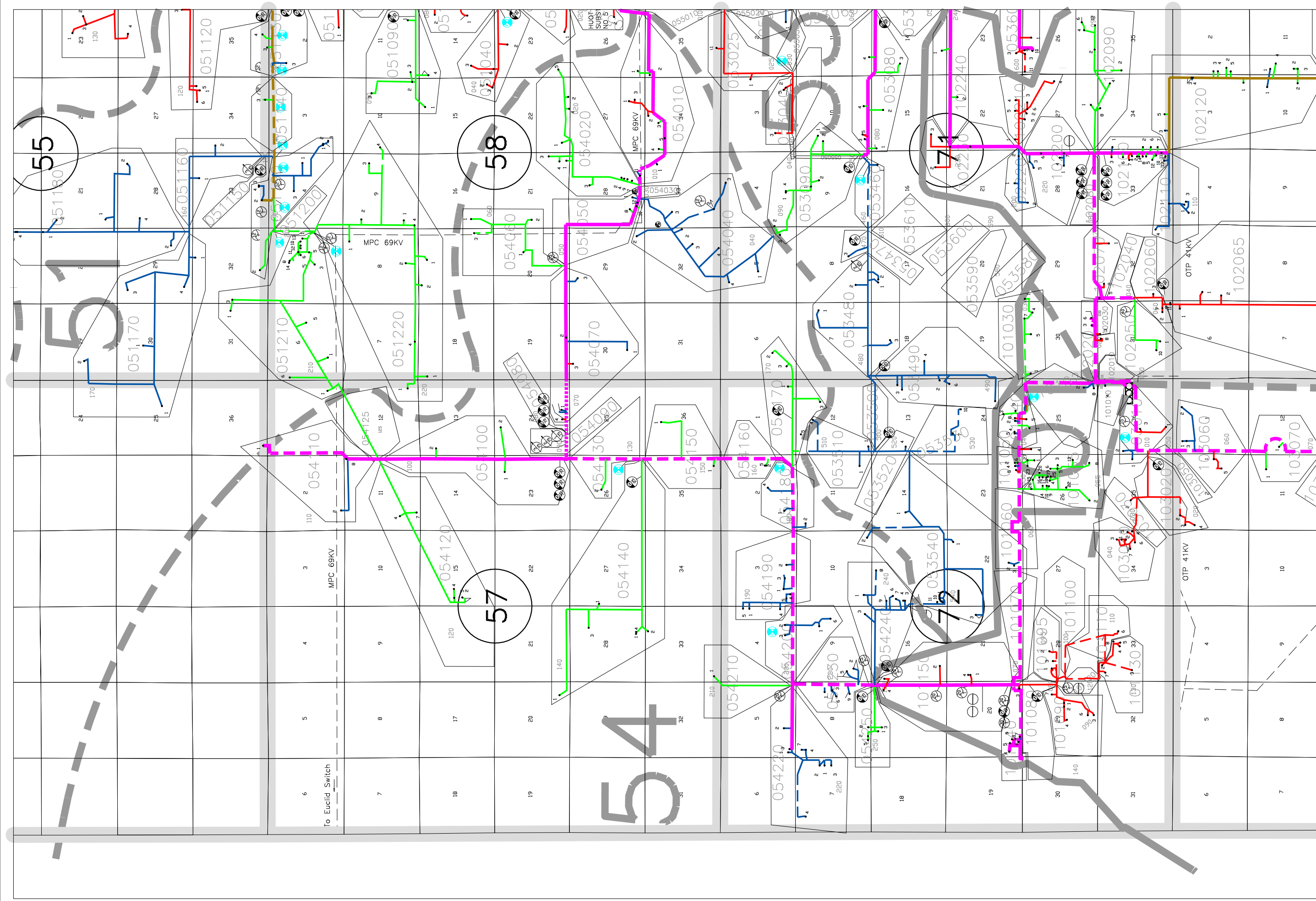

Red Lake Electric Coop., Inc.
 Red Lake Falls, Minnesota
 Minnesota 75 Red Lake

INSPECTION
 DATE:

- OSMOSE
- LINE CREW
- MEMBER SERVICES

MAP NO.
F054

Red Lake Electric Coop., Inc.
Red Lake Falls, Minnesota
Minnesota 75 Red Lake

INSPECTION
DATE:

OSMOSE

LINE CREW

MEMBER
SERVICES

MAP NO.

F061

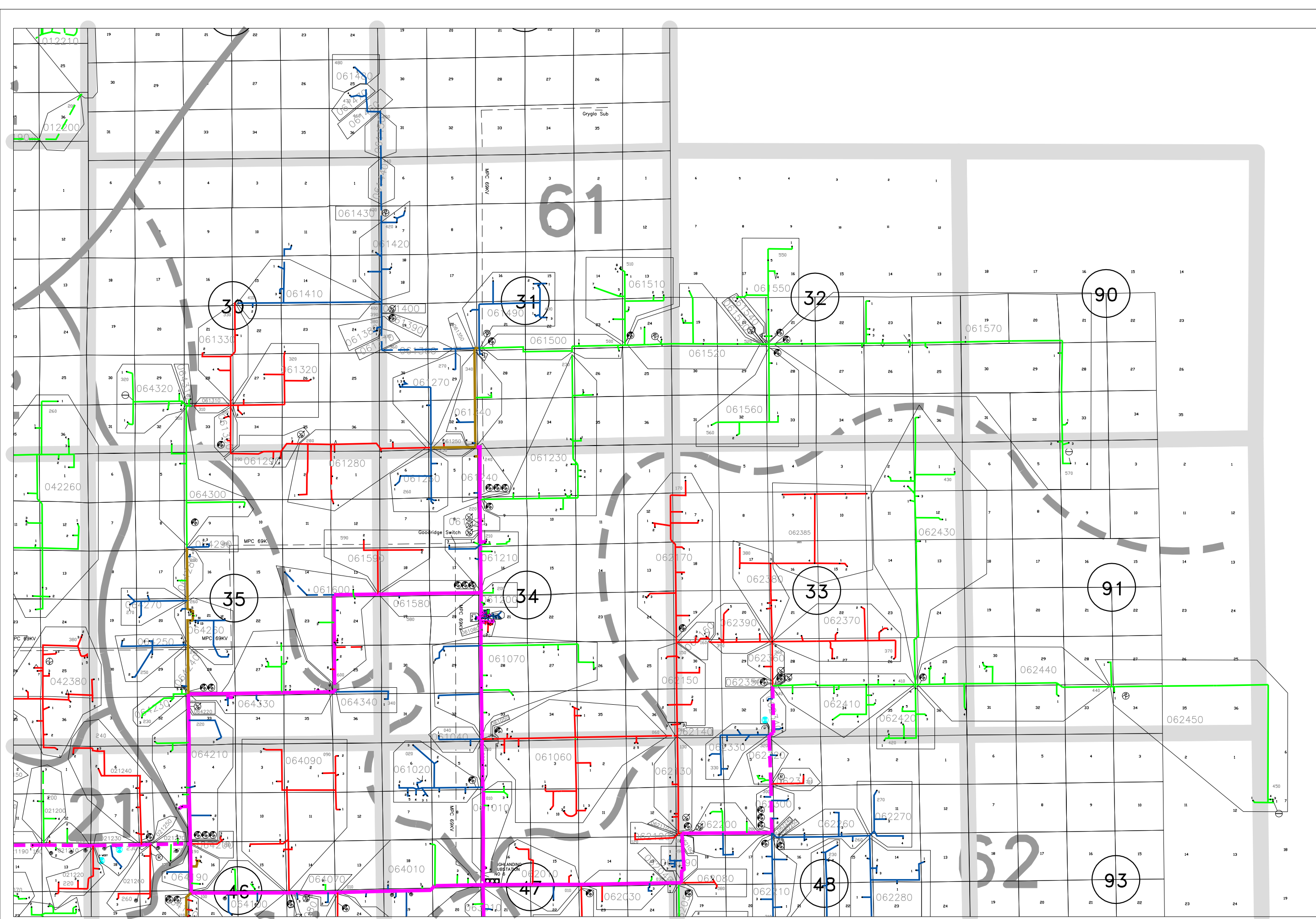

Red Lake Electric Coop., Inc.
Red Lake Falls, Minnesota
Minnesota 75 Red Lake

INSPECTION
DATE:

- OSMOSE
- LINE CREW
- MEMBER SERVICES

MAP NO.

F061A

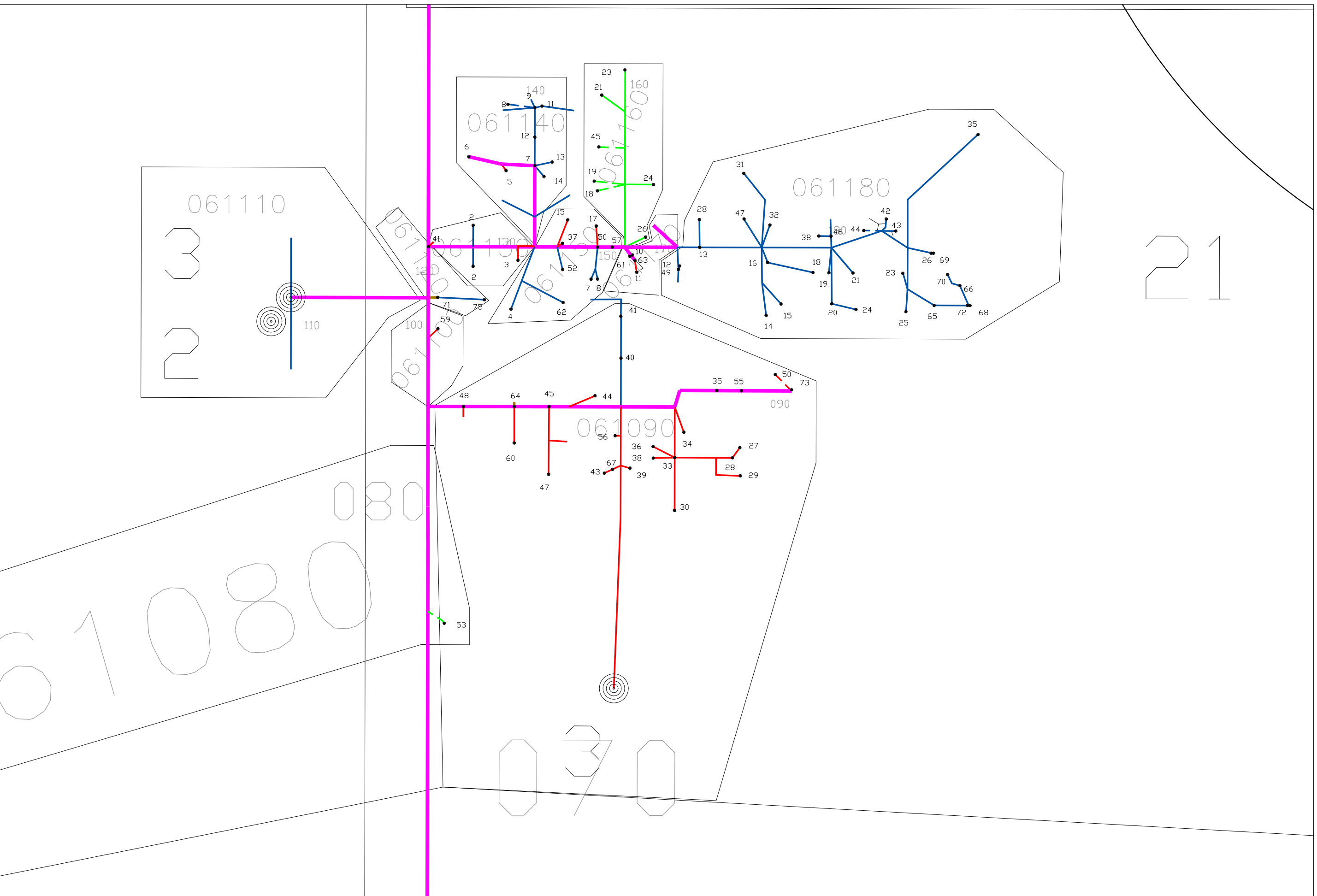

Red Lake Electric Coop., Inc.
Red Lake Falls, Minnesota
Minnesota 75 Red Lake

INSPECTION
DATE:

- OSMOSE
- LINE CREW
- MEMBER SERVICES

MAP NO.

F062

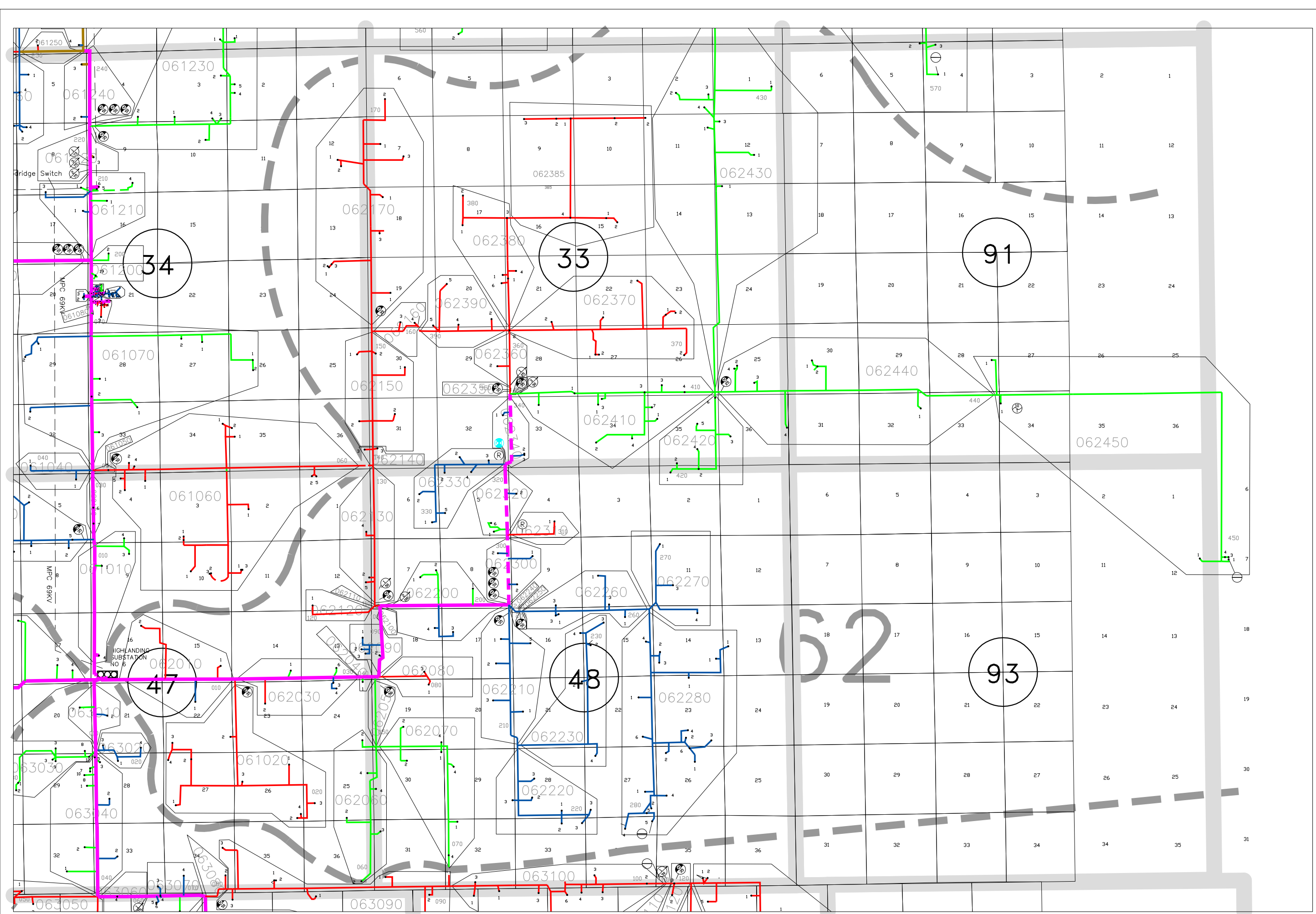

Red Lake Electric Coop., Inc.
Red Lake Falls, Minnesota
Minnesota 75 Red Lake

INSPECTION
DATE:

- OSMOSE
- LINE CREW
- MEMBER SERVICES

MAP NO.

F063

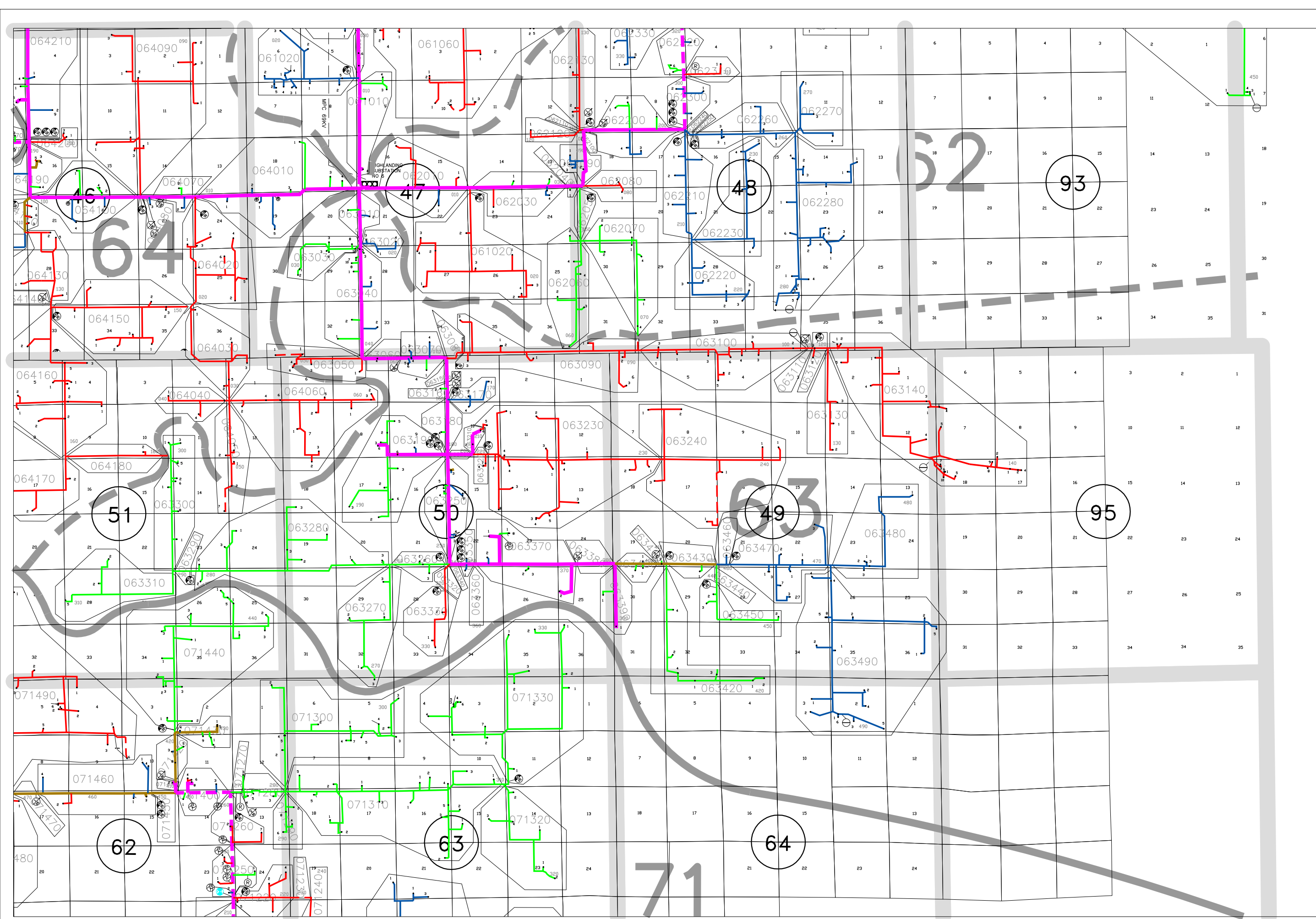

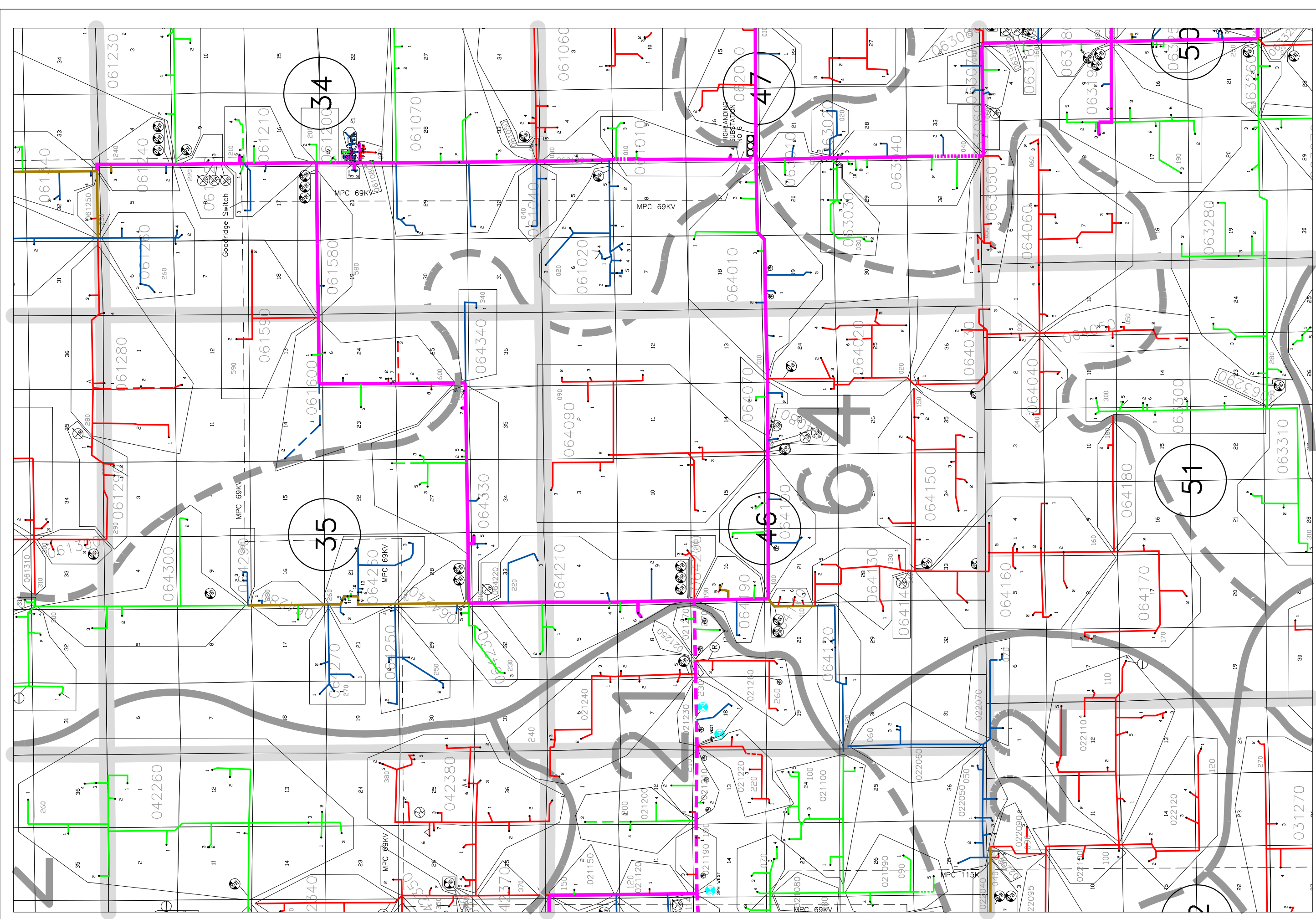

Red Lake Electric Coop., Inc.
 Red Lake Falls, Minnesota
 Minnesota 75 Red Lake

INSPECTION
 DATE:

- OSMOSE
- LINE CREW
- MEMBER SERVICES

MAP NO.
F064

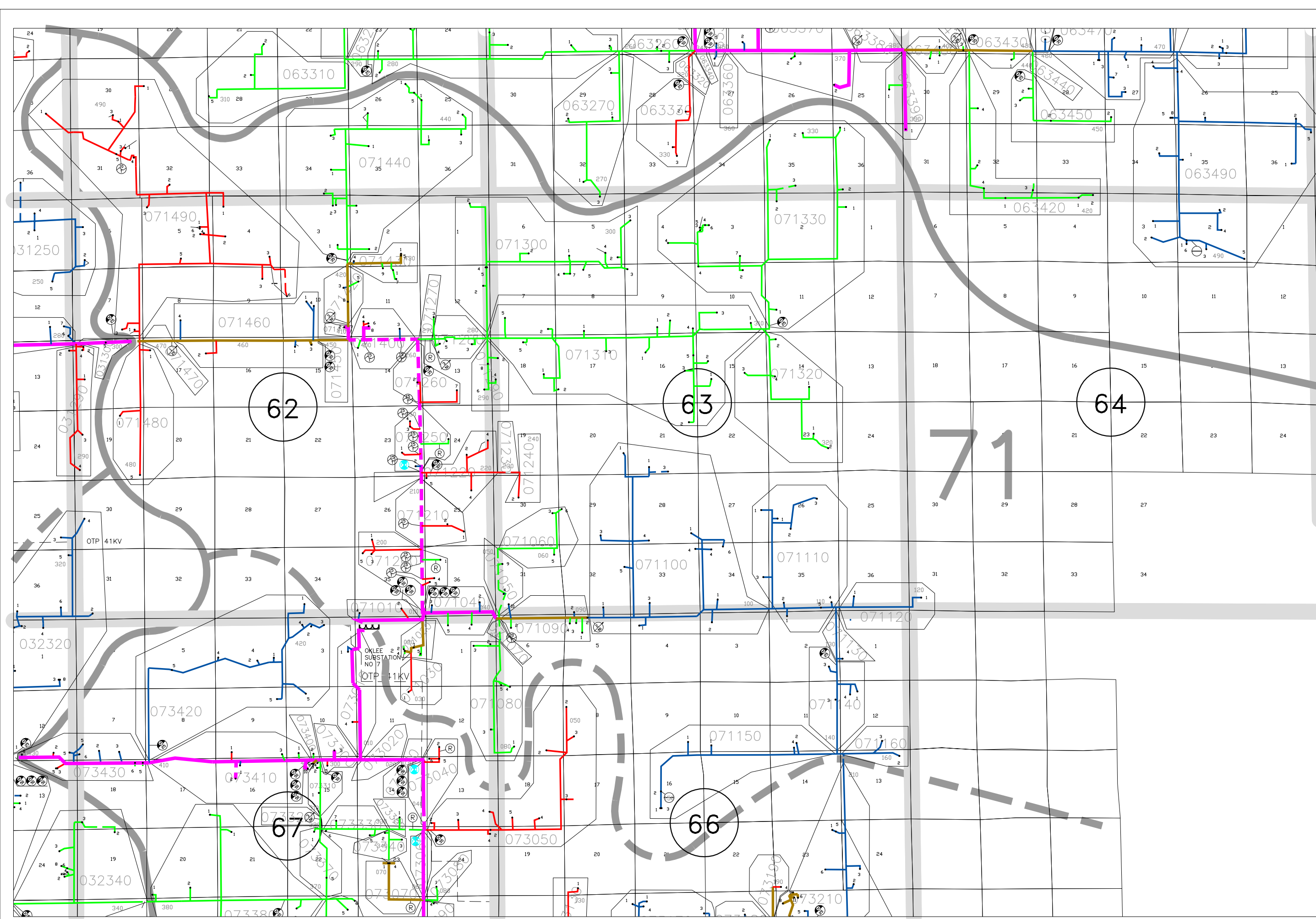

Red Lake Electric Coop., Inc.
 Red Lake Falls, Minnesota
 Minnesota 75 Red Lake

INSPECTION
 DATE:

- OSMOSE
- LINE CREW
- MEMBER SERVICES

MAP NO.
F071

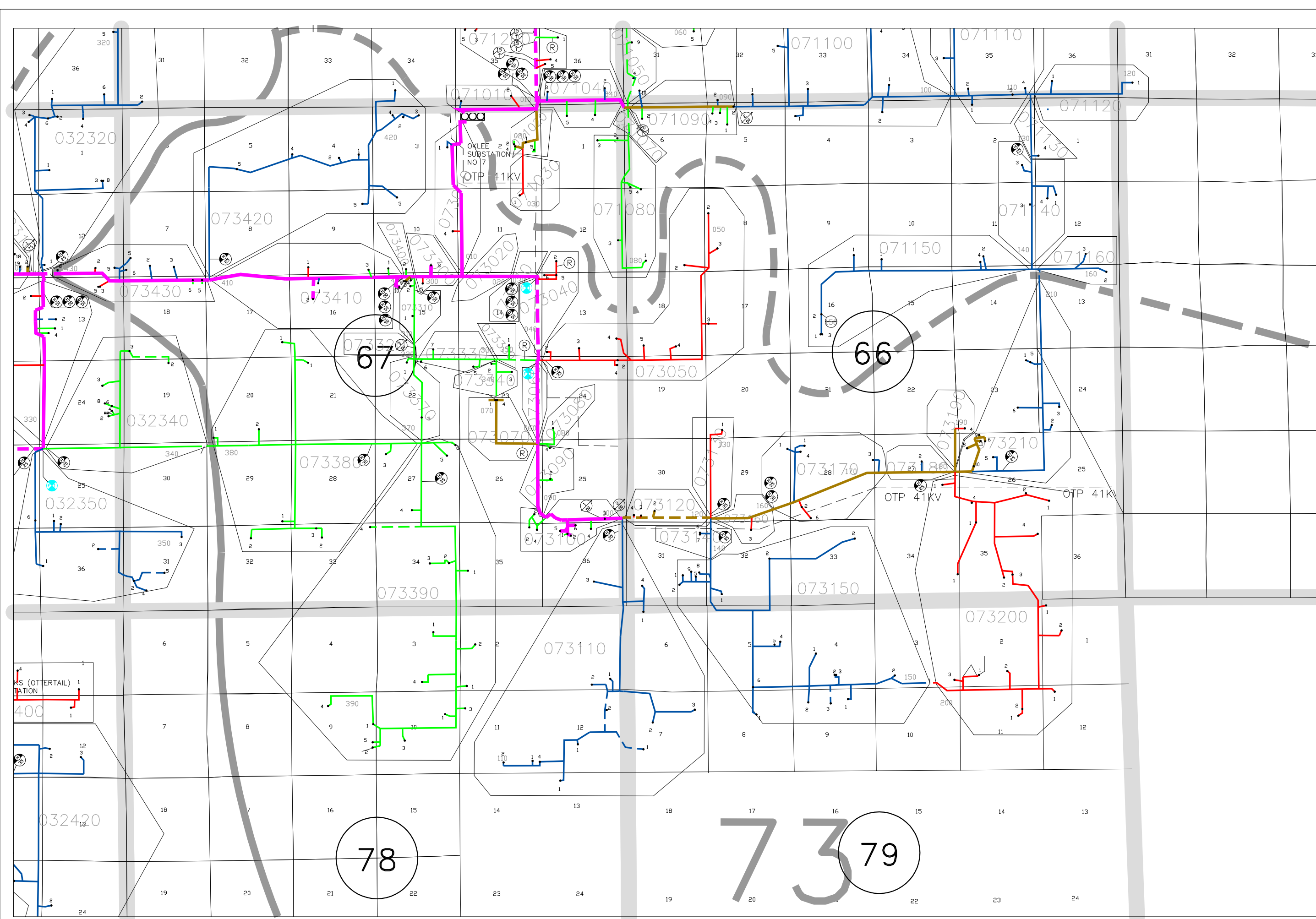

Red Lake Electric Coop., Inc.
 Red Lake Falls, Minnesota
 Minnesota 75 Red Lake

INSPECTION
 DATE:

- OSMOSE
- LINE CREW
- MEMBER SERVICES

MAP NO.
F073

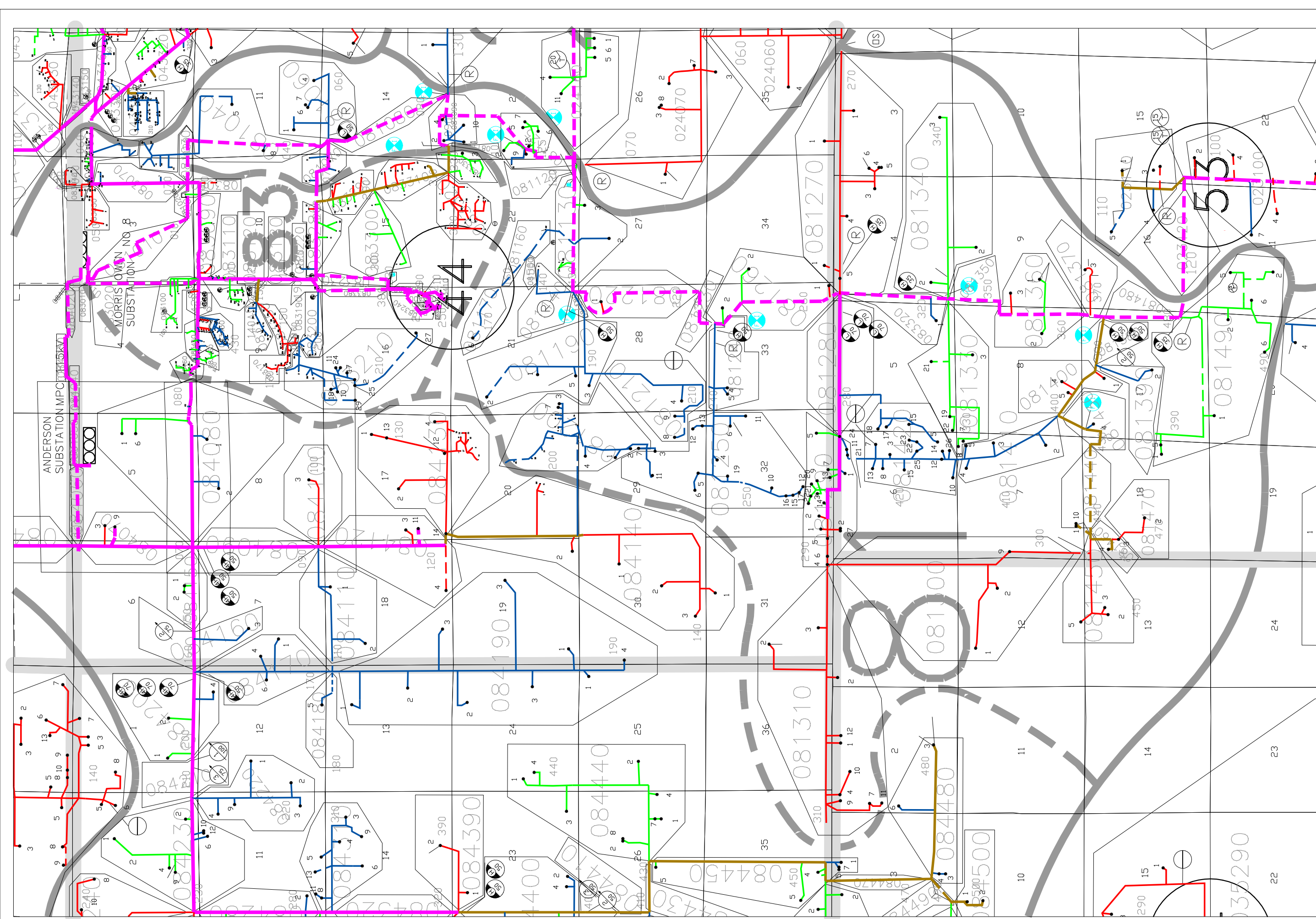

- INSPECTION DATE:
- OSMOSE
 - LINE CREW
 - MEMBER SERVICES

MAP NO.
F081

Red Lake Electric Coop., Inc.
 Red Lake Falls, Minnesota
 Minnesota 75 Red Lake

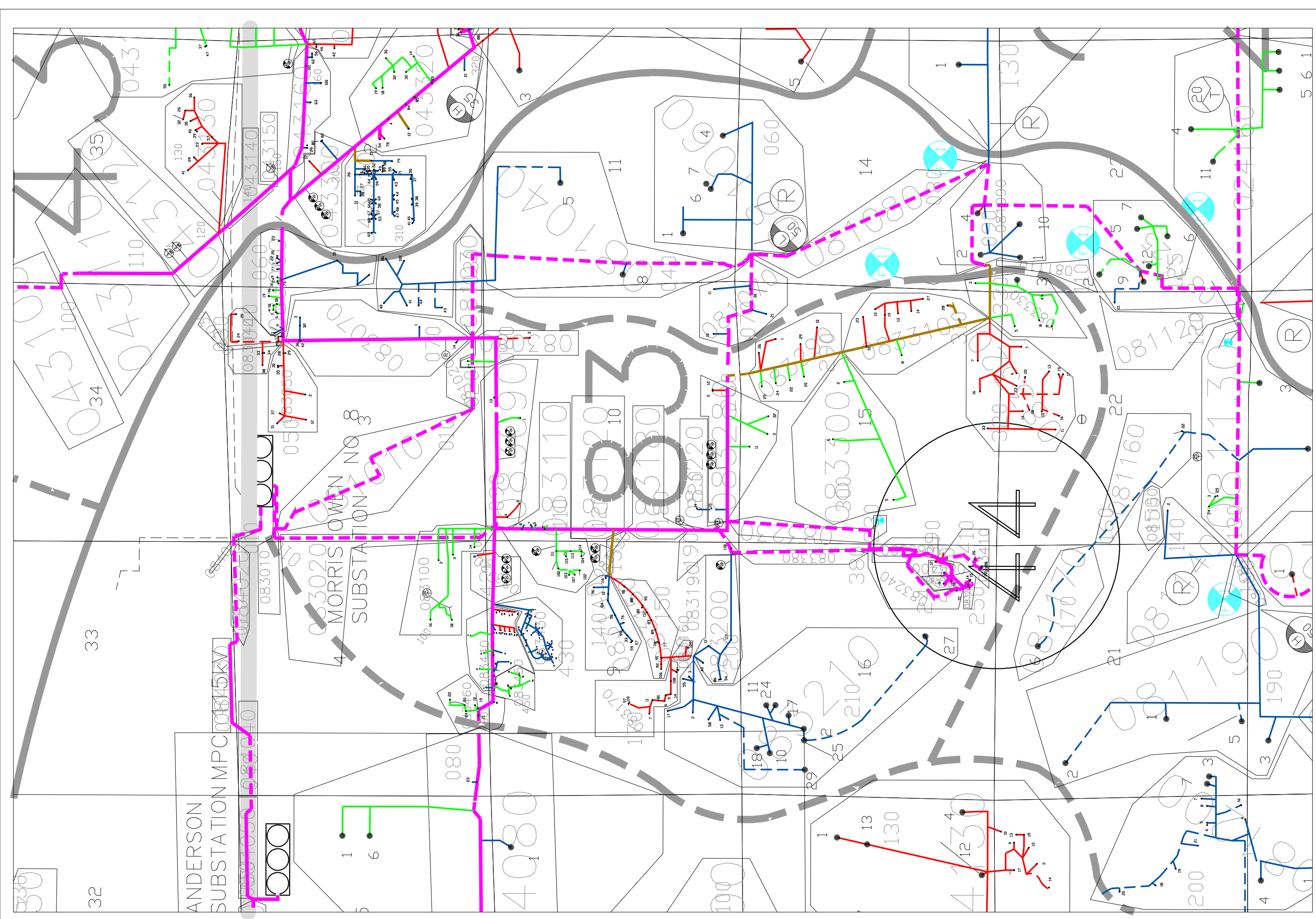

Red Lake Electric Coop., Inc.
 Red Lake Falls, Minnesota
 Minnesota 75 Red Lake

INSPECTION
 DATE:

- OSMOSE
- LINE CREW
- MEMBER SERVICES

MAP NO.
F083

Red Lake Electric Coop., Inc.
Red Lake Falls, Minnesota
Minnesota 75 Red Lake

INSPECTION
DATE:

- OSMOSE
- LINE CREW
- MEMBER SERVICES

MAP NO.

F083A

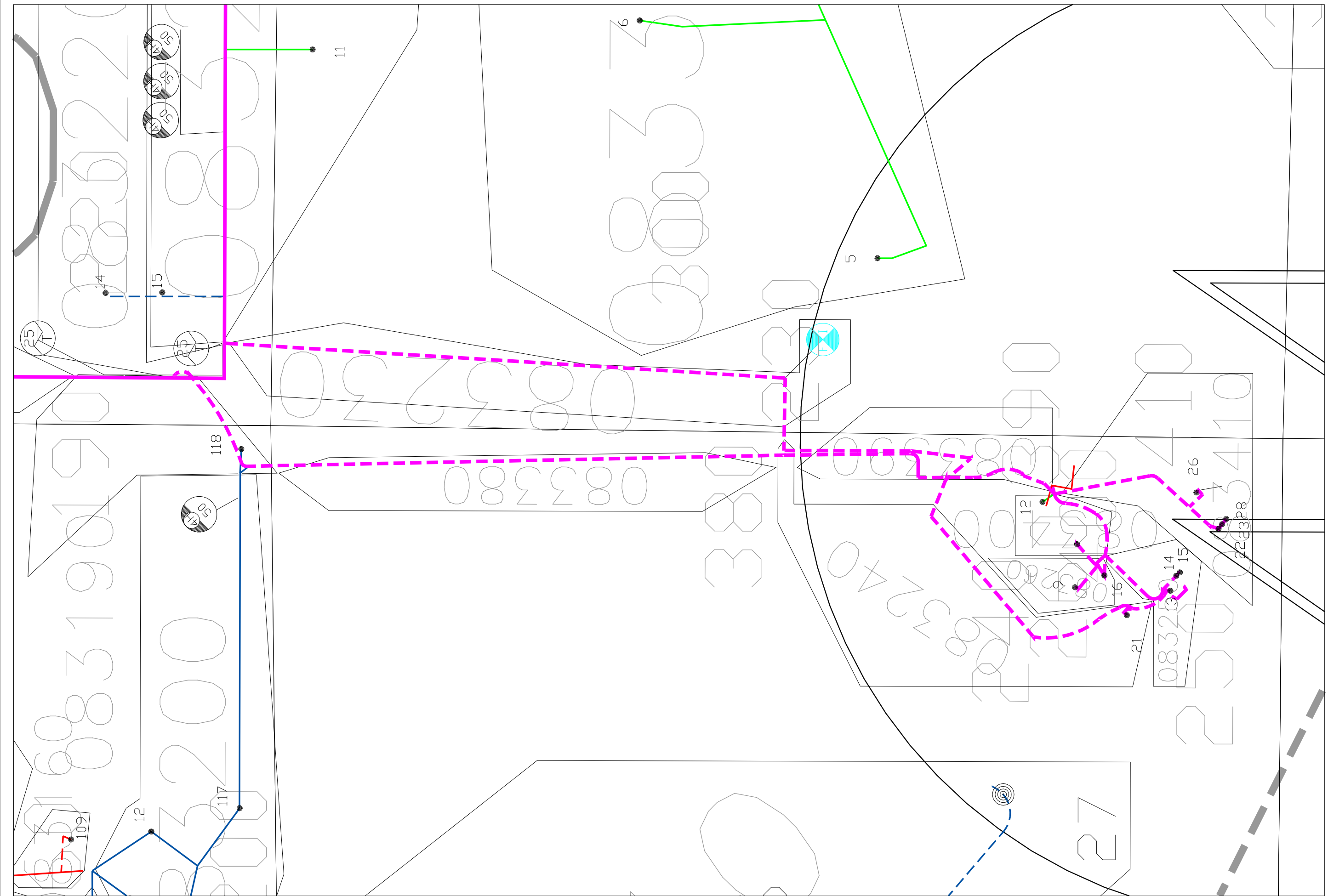

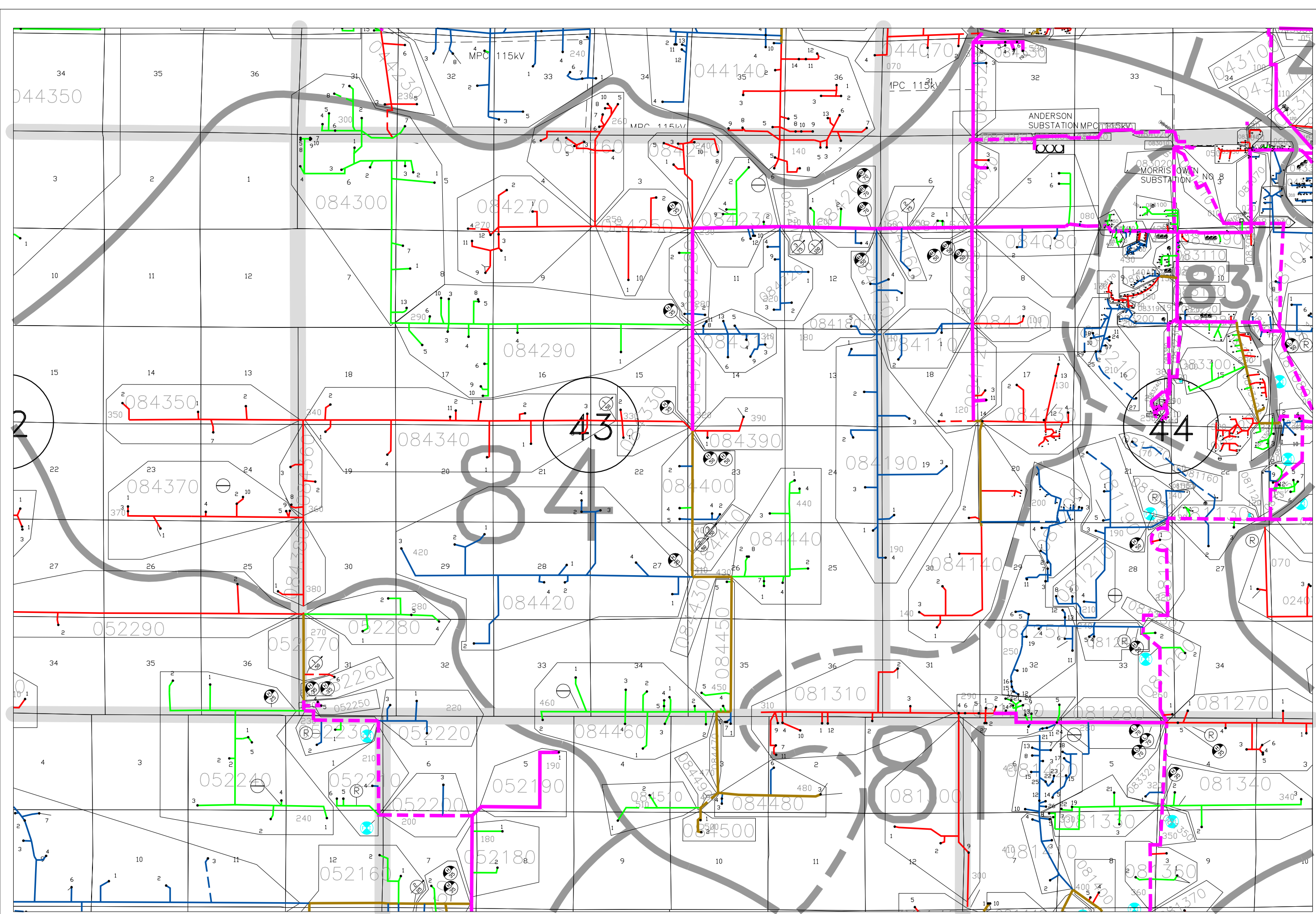

Red Lake Electric Coop., Inc.
 Red Lake Falls, Minnesota
 Minnesota 75 Red Lake

INSPECTION
 DATE:

- OSMOSE
- LINE CREW
- MEMBER SERVICES

MAP NO.
F084

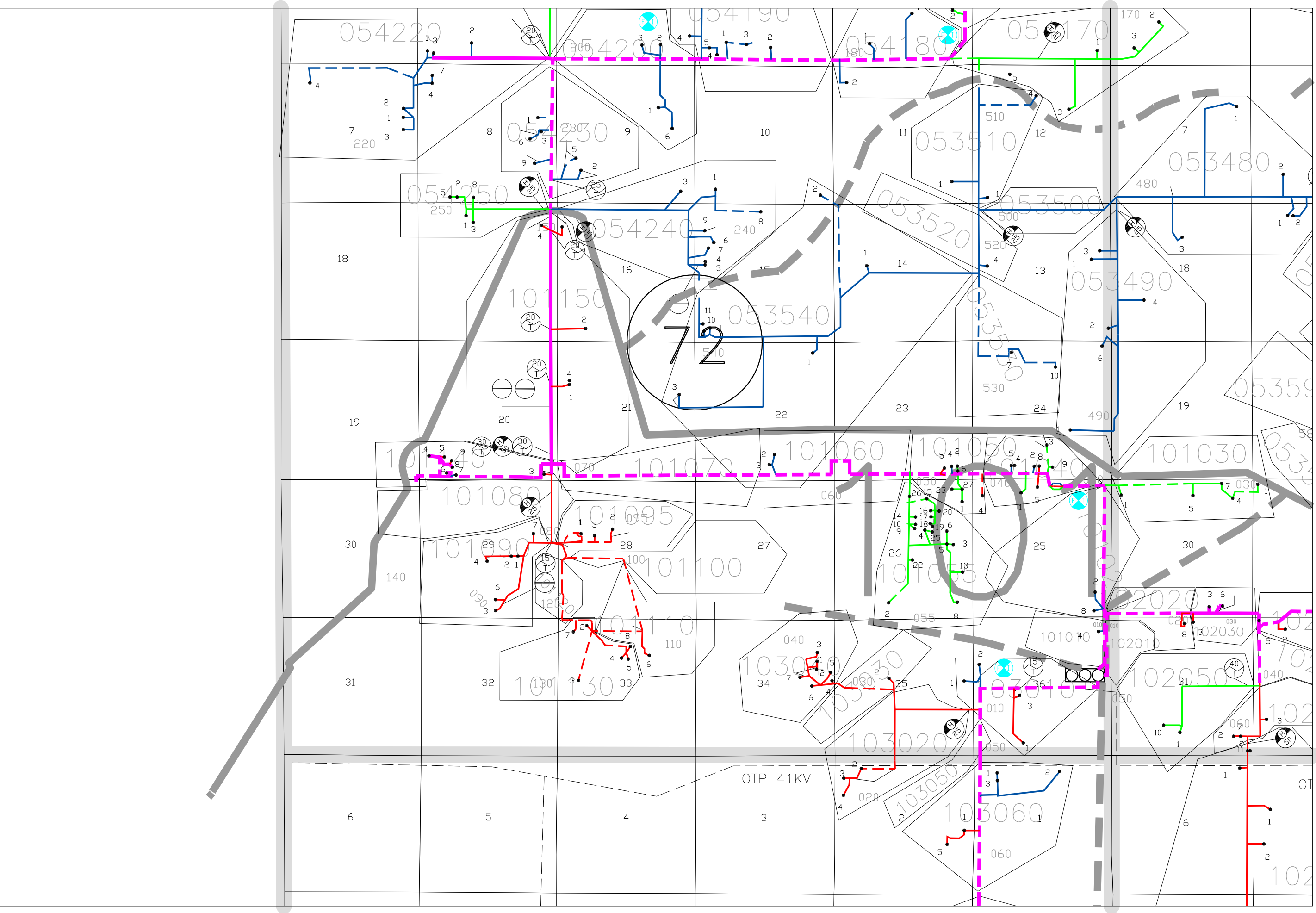

Red Lake Electric Coop., Inc.
 Red Lake Falls, Minnesota
 Minnesota 75 Red Lake

INSPECTION
 DATE:

- OSMOSE
- LINE CREW
- MEMBER SERVICES

MAP NO.
F101

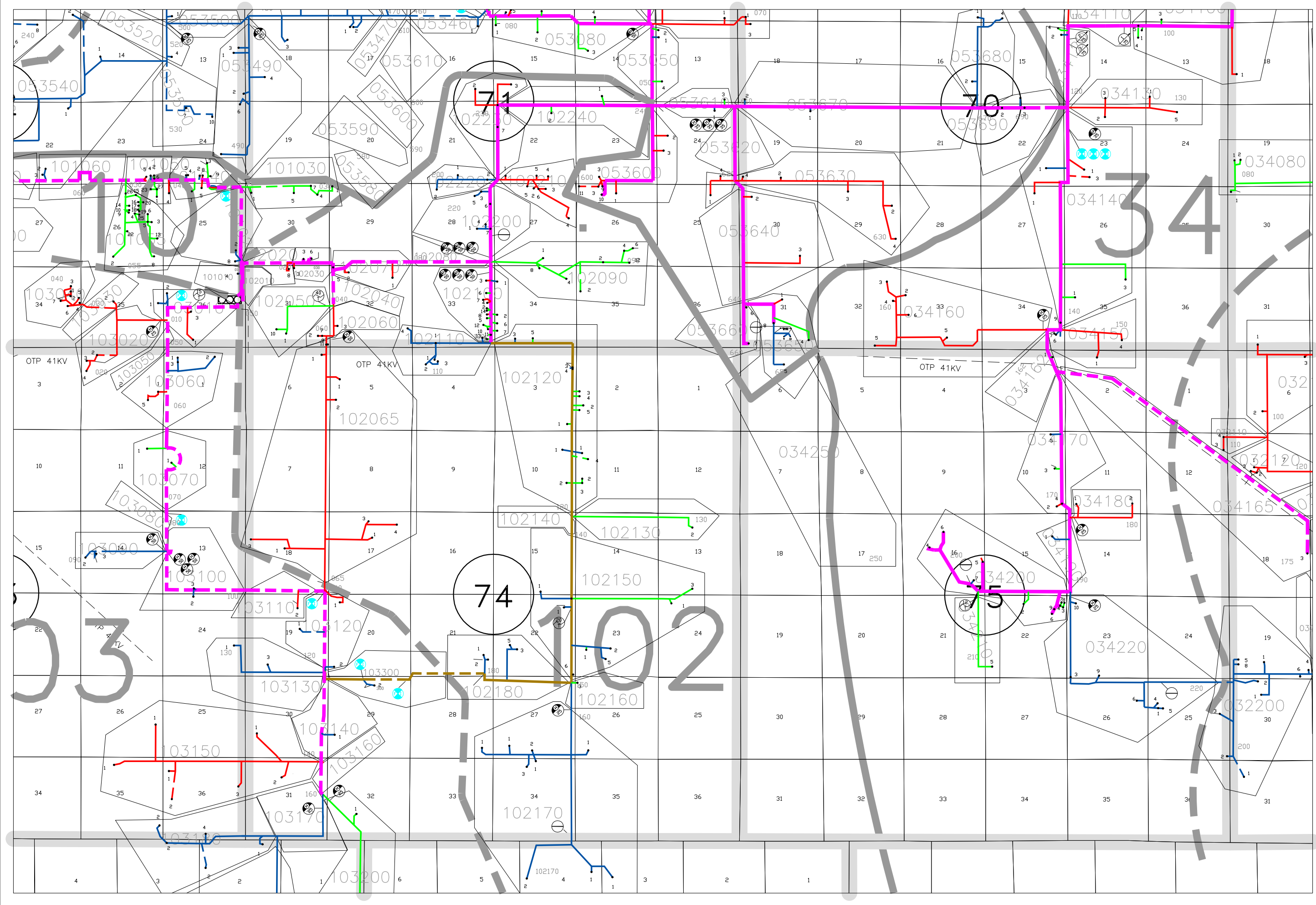

Red Lake Electric Coop., Inc.
 Red Lake Falls, Minnesota
 Minnesota 75 Red Lake

INSPECTION
 DATE:

- DSMOSE
- LINE CREW
- MEMBER SERVICES

MAP NO.
F102

